

G N C 3 0 0 X L



PILOT'S GUIDE AND REFERENCE



This manual is written for software version 2.04 or above, and is not suitable for earlier software versions.

© 1999 GARMIN Corporation, 1200 East 151st Street, Olathe, Kansas 66062 USA
Tel: 913-397-8200 Fax: 913-397-8282

GARMIN (Europe) LTD, Unit 5, The Quadrangle, Abbey Park, Romsey, Hampshire S051 9AQ, UK
Tel: 011-44-1794-519944 Fax: 011-44-1794-519222

GARMIN (Asia) Corp., 4th Fl., No. 1, Lane 45, Pao-Hsing Road, Hsin Tien, Taiwan R.O. C.
Tel: 011-886-02-2917-3773 Fax: 011-886-02-2917-1758

Web Site Address: www.garmin.com

All rights reserved. No part of this manual may be reproduced or transmitted in any form or by any means, electronic or mechanical, including photocopying and recording, for any purpose without the express written permission of GARMIN.

Information in this document is subject to change without notice. GARMIN reserves the right to change or improve their products and to make changes in the content of this material without obligation to notify any person or organization of such changes or improvements.



INTRODUCTION

Foreword

GARMIN, GNC 300XL, Spell'N'Find, AutoLocate, PhaseTrac12, GPSCOM and AutoStore are trademarks of GARMIN and may only be used with permission.

NavData® is a registered trademark of Jeppesen, Inc.

All rights reserved.



INTRODUCTION

Cautions

NOTE: This device complies with Part 15 of the FCC limits for Class B digital devices. This equipment generates, uses, and can radiate radio frequency energy and, if not installed and used in accordance with the instructions, may cause harmful interference to radio communications. Furthermore, there is no guarantee that interference will not occur in a particular installation.

If this equipment does cause harmful interference, the user is encouraged to try to correct the interference by relocating the equipment or connecting the equipment to a different circuit than the affected equipment. Consult an authorized dealer or other qualified avionics technician for additional help if these remedies do not correct the problem.

Operation of this device is subject to the following conditions: (1) This device may not cause harmful interference, and (2) this device must accept any interference received, including interference that may cause undesired operation.

The GARMIN GNC 300XL does not contain any user-serviceable parts. Repairs should only be made by an authorized GARMIN service center. Unauthorized repairs or modifications could void your warranty and authority to operate this device under Part 15 regulations.

CAUTION

The Global Positioning System is operated by the United States government, which is solely responsible for its accuracy and maintenance. The system is subject to changes which could affect the accuracy and performance of all GPS equipment. Although the GARMIN GNC 300XL is a precision electronic NAVigation AID (NAVAID), any NAVAID can be misused or misinterpreted and therefore become unsafe.

Use the GNC 300XL at your own risk. To reduce the risk of unsafe operation, carefully review and understand all aspects of this Owner's Manual and the Flight Manual Supplement, and thoroughly practice using the simulator mode prior to actual use. When in actual use, carefully compare indications from the GNC 300XL to all available navigation sources, including the information from other NAVAIDS, visual sightings, charts, etc. For safety, always resolve any discrepancies before continuing navigation.

The altitude calculated by the GNC 300XL is geometric height above mean sea level and could vary significantly from altitude displayed by pressure altimeters in aircraft. **Never** use GPS altitude for vertical navigation.

The Jeppesen database incorporated in the GNC 300XL must be updated regularly in order to ensure that its information is current. Updates are released every 28 days. A database information packet is included in your GNC 300XL package.

Pilots using an out-of-date database do so entirely at their own risk.

Accessories & Packing List

Congratulations on choosing the finest, most advanced panel mount IFR GPSCOM available. The GNC 300XL represents GARMIN's commitment to provide an accurate, easy-to-use GPS for all of your aviation needs.

Before installing and getting started with your unit, please check to see that your package includes the following items. If any parts are missing or damaged, please see your GARMIN dealer immediately.

Standard Package:

- GNC 300XL Unit & NavData® Card
- GPS Antenna
- Installation Rack & Connectors
- Pilot's Guide & Quick Reference Guide
- Database Subscription Packet
- Warranty Registration Card

Optional Accessories:

- Remote Battery Pack
- AC Adapter
- PC Software/Interface Kit
- User Data Card
- 28 to 14 volt DC converter
- MD-41 External Switch/Annunciator



INTRODUCTION

Accessories and Packing List

*To obtain accessories for your GNC 300XL,
please contact your nearest GARMIN dealer.*



INTRODUCTION

Warranty

To obtain warranty service, see your local dealer or call the GARMIN Customer Service department for a returned merchandise tracking number. The unit should be securely packaged with the tracking number clearly marked on the outside of the package, and sent freight prepaid and insured to a GARMIN authorized warranty service facility.

GARMIN is fully committed to your satisfaction as a customer. If you have any questions regarding the GNC 300XL, please contact our customer service department at:

*GARMIN International, Inc.
1200 East 151st Street
Olathe, KS 66062-3426
(913) 397-8200
FAX (913) 397-8282*

Every GARMIN GPS is built to exacting standards to provide years of trouble-free service. GARMIN warrants this product to be free from defects in materials and workmanship for one year from the date of purchase.

GARMIN International, Inc. will at its sole option, repair or replace any components which fail in normal use. Such repairs or replacement will be made at no charge to the customer for parts or labor. The customer is, however, responsible for any transportation costs. This warranty does not cover failures due to abuse, misuse, accident or unauthorized alteration or repairs. GARMIN International, Inc. assumes no responsibility for special, incidental, punitive or consequential damages, or loss of use.

THE WARRANTIES AND REMEDIES CONTAINED HEREIN ARE EXCLUSIVE, AND IN LIEU OF ALL OTHER WARRANTIES EXPRESSED OR IMPLIED, INCLUDING ANY LIABILITY ARISING UNDER WARRANTY OF MERCHANTABILITY OR FITNESS FOR A PARTICULAR PURPOSE, STATUTORY OR OTHERWISE. THIS WARRANTY GIVES YOU SPECIFIC LEGAL RIGHTS, WHICH MAY VARY FROM STATE TO STATE.

PART ONE: INTRODUCTION

| | |
|--------------------------|----------|
| Foreword | i |
| Cautions | ii |
| Accessories/Packing List | iii |
| Warranty | iv |
| Table of Contents | v-vi |
| Key and Knob Functions | vii-viii |
| GNC 300XL Takeoff Tour | 1-10 |

PART TWO: REFERENCE

| | |
|---|----|
| Section 1: Navigation with the GNC 300XL (NAV key) | 11 |
| Navigating and planning functions | |
| Section 2: Communicating with the GNC 300XL | 33 |
| Using standby/active frequencies and auto-tune | |
| Section 3: Waypoint and Database Information (WPT key) | 36 |
| Finding and using database and waypoint information | |
| Section 4: Nearest Waypoints (NRST key) | 57 |
| Finding nearest waypoints, SUAs and FSS/ARTCC frequencies | |
| Section 5: Direct-to (D→ key) & Route Navigation (RTE key) | 62 |
| Creating and using routes | |
| Section 6: Approaches, SIDs and STARs (RTE key) | 78 |
| Selecting and flying non-precision approaches | |



To quickly and easily locate information on specific tasks, please refer to the Index on page 135.



INTRODUCTION

Table of Contents

| | |
|--|-----|
| Section 7: Messages and Unit Settings ( key) | 100 |
| Appendix A: NavData® and User Data Card Use | 112 |
| Appendix B: Installation and Maintenance of the GNC 300XL | 114 |
| Appendix C: Simulator | 115 |
| Appendix D: GNC 300XL Messages and Abbreviations | 117 |
| Appendix E: Specifications | 126 |
| Appendix F: Map Datums | 127 |
| Appendix G: Troubleshooting Q & A | 129 |
| Appendix H: Index | 135 |

Key and Knob Functions



The **power/volume knob** controls unit power and radio volume.

SQ

The **squelch button** activates automatic squelch control.



The **direct-to key** performs an instant direct-to, allows you to enter a waypoint, and sets a direct course to the destination. See Section 5.

NRST

The **nearest key** is used to obtain information on the 9 nearest airports, VORs, NDBs, intersections, user waypoints and 2 nearest FSS/ARTCC points of communication. The nearest key also accesses any active SUA information. See Section 4 for more information on the nearest waypoints.

RTE

The **route key** enables you to create, edit, activate and invert routes, and access approaches, SIDs and STARs. Search-and-rescue, parallel offset and closest point of approach functions are also performed using the route key. See Section 5 for more route information on routes and Section 6 for more information on approaches, SIDs and STARs.

WPT

The **waypoint key** is used to view information such as runways, frequencies, position and comments on airports, VORs, NDBs, intersections and user waypoints. See Section 3 for more waypoint information.

NAV

The **navigation key** is used to view navigation and position information. Planning operations are also performed using this key. See Section 1 for more information on navigation and planning operations.



INTRODUCTION

Key and Knob Functions

The GNC 300XL is designed to minimize keystrokes when performing operations. There are typically several ways to perform the same operation. In general, using the knobs will decrease keystrokes and time spent using the GNC 300XL. Experiment to find the most effective way to use the GNC 300XL to your advantage.

INTRODUCTION

Key and Knob Functions

This manual will describe entering data using the  and  knobs. Experiment with them and become efficient in entering data with the concentric knobs. This will greatly reduce the amount of time required to navigate with the GNC 300XL.

```
118.30 124.30
KIXD uni 122.95
      gndo 124.30
      ↓twro 118.30
```

Whenever the GNC 300XL is displaying a list of information that is too long for the display screen, the scrolling arrow prompt will indicate which direction to scroll to view additional information. To scroll through a list (with the cursor active), simply rotate the inner knob. When the cursor is not active, use the outer knob to view additional information.

MSG

The **message key** is used to view system messages and to alert you to important warnings and requirements. This key is also used to access the GNC 300XL's unit settings. See Section 7 for more information on messages and unit settings.



The **transfer key** flip-flops the active and standby frequencies.

CLR

The **clear key** is used to erase information or cancel an entry.

ENT

The **enter key** is used to approve an operation or complete data entry. It is also used to confirm information, such as during power on.

CRSR

The **cursor key** is used to activate or deactivate the cursor in the separate areas of the GNC 300XL. Pressing once will activate the cursor in the comm 'window' and enable the pilot to change frequencies. Pressing twice will activate the cursor in the GPS window (indicated by highlighted characters in a GPS window field). It is used to highlight fields for data entry, changing information or cycling through available options. Pressing a third time will deactivate the cursor.



The **outer knob** is used to advance through pages, advance the cursor or move through data fields.



The **inner knob** is used to change data or scroll through information that cannot fit on the screen all at once.

The GARMIN GNC 300XL is a powerful navigational tool that provides pilots with accurate navigational data and communication capability, along with along with non-precision approach certification in the IFR environment. The Takeoff Tour is designed to familiarize you with the operation of the GNC 300XL, including powering up the unit, changing frequencies, entering data and performing a simple direct-to, and provide a limited introduction to the 'Nearest' functions. In addition, this section also briefly covers the position, CDI, map and frequency pages available from the NAV key. These pages will be used for most of your in-flight navigation.

The Takeoff Tour assumes that the GPSCOM™ and antennas have been properly installed and you have not changed any of the GNC 300XL's default settings. If you have changed any of the factory default settings (position format, units of measure, selectable fields, etc.), the pictures shown here may not match your configuration. Prior to using your GNC 300XL for the first time, we recommend that you taxi to a location that is well away from buildings and other aircraft so the unit can collect satellite data without interruption.

Powering up the GNC 300XL

The GNC 300XL's power and volume are controlled using the  (power/volume) knob at the bottom left of the unit. Rotating it clockwise will turn unit power on and increase the radio volume. After turning the unit on, a **welcome page** will be displayed while the unit performs a self test.

The **database page** will appear next, showing the current database information on the NavData card, with the valid operating dates, cycle number and database type indicated. The database is updated every 28 days, and must be current for approved approach and IFR operations. Information on database subscriptions is available inside your GNC 300XL package.

To acknowledge the database information:

1. Press the  key.

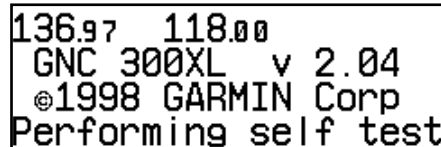

The welcome page appears when the GNC 300XL is turned on. During the time this screen is displayed, the GNC 300XL performs a self test to ensure proper operation.

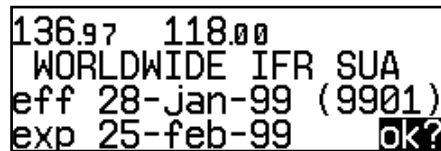

The database confirmation page shows the effective and expiration dates of the Jeppesen database on the NavData Card.

TAKEOFF TOUR

Acquiring Satellites





```
122.80 118.30
Acquiring epe____fT
sat 1 3 5 6 9 13 17 19→
sgl 9 6 - 3 - 7 9 -
```



The satellite status page shows the ID numbers for the satellites and the relative signal strength of each satellite received. Turn the  knob to view additional satellites.

```
122.80 118.30
Search Sky epe____fT
sat 1
sgl -
```

'Search Sky' indicates that satellite almanac data is not available or has expired (if the unit hasn't been used for six months or more). The data will be recollected from the first available satellite.

Once the database has been acknowledged, the **satellite status page** will appear, and the GNC 300XL will begin to collect satellite information. An 'Acquiring' status will be displayed on the satellite status page, and the signal values on the bottom line of the page will begin displaying numeric values. This is a good indication that you are receiving signals and satellite lock will occur. Following the first-time use of your GNC 300XL, the time required for a position fix will vary — usually from one to two minutes.

If the unit can only obtain enough satellites for 2D navigation (no altitude), the unit will use the altitude provided by your altitude encoder (if one is connected and working). If not, you will be prompted to enter the altitude with a 'Need alt- Press NAV' message. If this message occurs, press the  key and use the  and  knobs to enter the altitude shown on your altimeter. Press  when finished.

If the GNC 300XL has not been operated for a period of six months or more, it may have to 'Search the Sky' to collect new data. This means the unit is acquiring satellite data to establish almanac and satellite orbit information, which can take 5 to 10 minutes. The satellite status page will display a 'Search Sky' status, and the message annunciator , next to the  key, will also flash to alert you of a system message — 'Searching the Sky'.

To view a system message:

1. Press .

The **message page** will appear and display the status or warning information applicable to the receiver's current operating condition.

To return to the previous page after viewing a message:

1. Press  again.

While the GNC 300XL is acquiring a position, let's take a minute to dial in the active and standby frequencies you'll be using for the first phase of your flight. The GNC 300XL's display can be broken down into two separate 'windows' (or screen areas), the **comm window** (the top line of the display) and the **GPS window** (the bottom three lines of the display).

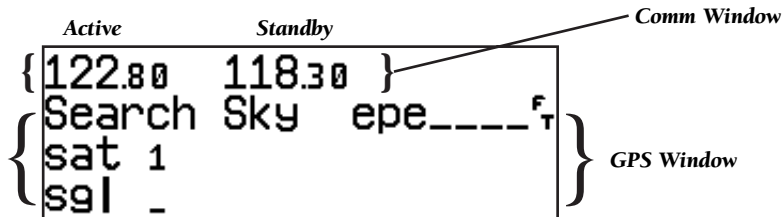

The **CRSR** key is used to activate the cursor in a particular window (see right) to provide access to various comm and navigation features. To select the active frequency, you must first enter the frequency in the standby field, and use the **←→** key to move it to the active field.

To change the standby communication frequency:

1. Press **CRSR** once to activate the cursor in the comm window.
2. Rotate the outer knob (○) to select the MHz, and the inner knob (●) to select the kHz of the desired frequency.

To place the standby frequency in the active field, press **←→**.

Once you've entered the active frequency, simply repeat steps 1 and 2 to enter the standby frequency. After both frequencies have been entered, you may elect to keep the comm window 'hot' by leaving the cursor on the standby frequency, or remove the cursor by pressing the **CRSR** key twice.

TAKEOFF TOUR

Selecting Comm Frequencies

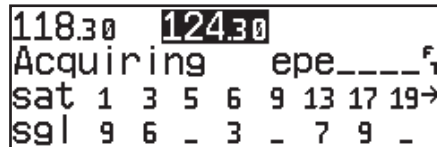

Status page with cursor active in comm window.

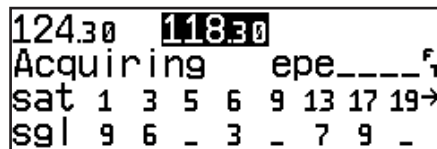

To switch the active and standby frequencies, press the **←→** key. Switching the active and standby frequencies will not remove the cursor from the comm window.

TAKEOFF TOUR

Position Page

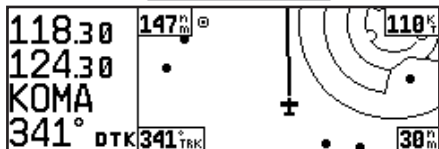

The map page combines a moving map display and navigation data for complete situational awareness.

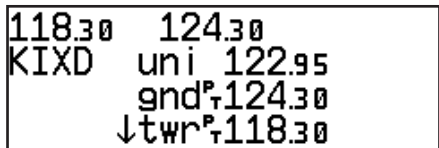

The navigation communications (NAVCOM) page provides a complete list of airport frequencies at your departure and arrival airports.

After the GNC 300XL acquires satellites and computes a position, the **position page** will appear automatically, and you'll be informed with 'Ready for navigation' on the message page.

Altitude, MSA or ESA



Position (lat/lon)

Reference Waypoint Field

The position page displays your present latitude and longitude, altitude and a reference waypoint field. The altitude and reference waypoint fields are also selectable (see Section 1 for more information) to allow you to configure the unit to your own preferences. The default settings are:

- **Altitude**— Your present GPS altitude
- **Present Position**— Latitude and longitude displayed in degrees/minutes
- **Reference Waypoint**— The bearing and distance to the nearest airport

The position page is one of seven pages available under the GNC 300XL's **NAV** key:

- **CDI page**
- **NAVCOM page**
- **Satellite status page**
- **NAV menu 2**
- **Map page**
- **Position page**
- **NAV menu 1**





During most flights, the position, CDI (course deviation indicator), map and NAVCOM pages will be the primary pages used for navigation. These pages are accessible by pressing the **NAV** key and rotating the outer knob, or by pressing the **NAV** key repeatedly.

TAKEOFF TOUR

Direct-To Navigation

The GNC 300XL uses direct point-to-point navigation to guide you from takeoff to touchdown in the IFR environment. Once a destination is selected, the unit will provide speed, course and distance data based upon a direct course from your present position to your destination. A destination can be selected from any page with the  (direct-to) key.

To select a direct-to destination:

1. Press the  key. The CDI page will appear with the destination field highlighted.
2. Rotate the  knob to enter the first letter of the destination waypoint identifier. The destination waypoint may be an airport, VOR, NDB, intersection or user waypoint, as long as it is in the database or stored in memory as a user waypoint.
3. Rotate the  knob to the right to move the cursor to the next character position.
4. Repeat steps 2 and 3 to spell out the rest of the waypoint identifier.
5. Press  to confirm the identifier. The direct-to confirmation page will appear.
6. Press  to confirm the destination.

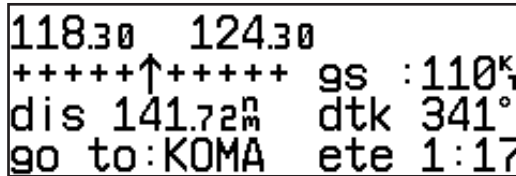

```
118.30 124.30
+++++↑+++++ gs :110kT
dis 141.72M dtk 341°
go to:KOMA ete 1:17
```

Once the direct-to destination is confirmed, the **CDI page** will appear with the destination indicated in the lower left hand corner of the screen. Your present speed and track over the ground, and the distance and estimated time en route to your destination are also displayed. The graphical CDI (course deviation indicator), located at the top left of the screen, displays your position relative to the desired course and provides turn anticipation and waypoint messages during route navigation.

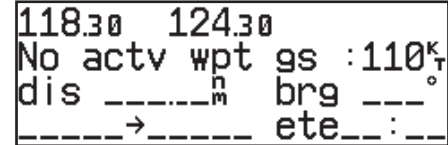

```
118.30 124.30
No actv wpt gs :110kT
dis _____M brg ____°
----->----- ete__:_
```

The CDI page without a direct-to destination or active route appears blank, except for ground speed (GS) and track (TRK) figures, if displayed.



```
118.30 124.30
go to apt:KOMA
N41°18.12' W095°53.62'
auto crs 338° ok?
```

When a destination is selected the direct-to confirmation page appears to verify the destination you selected. The lat/long, facility name or city may be displayed by highlighting the position field (third display line) and rotating the  knob.

TAKEOFF TOUR

CDI & Map Pages

```
118.30 124.30
+++++↑+++++ gs :110KT
dis 138.25M trk 341°
go to:KOMA eta12:35
```

CDI page with 'trk' and 'eta' displayed.

```
118.30 124.30
+++++↑+++++ gs :110KT
dis 137.42M brg 341°
go to:KOMA trk 341°
```

CDI page with 'brg' and 'trk' displayed.

In addition to the destination field and graphical CDI, the GNC 300XL CDI page features four selectable fields for various navigation data so that the page may be configured to your own preferences (see Section 1 for more information). The default settings for the CDI page are:

- **Ground Speed (gs)**— Your present speed over the ground in knots
- **Distance (dis)**— The distance to your destination in nautical miles
- **Desired Track (dtk)**— The course between the 'from' and 'to' waypoints
- **Estimated Time En route (ete)**— The time to your destination (in hours and minutes) based upon your present speed and course

The next page available from the **NAV** key is the **map page**. The map page combines the primary navigation information from the CDI page – distance to waypoint, ground speed, desired track and ETE – with a moving map display. The moving map display shows your current position (using an airplane symbol or a diamond symbol) relative to nearby airports, VORs, NDBs, intersections, user waypoints and airspace boundaries.

The map page can be divided into three main sections:

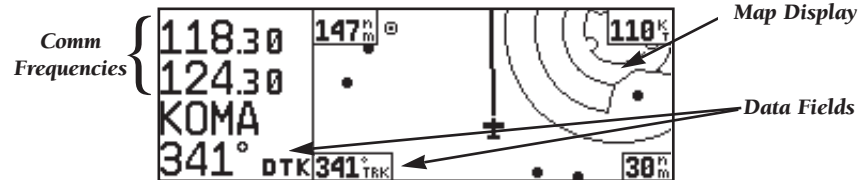

The **communication frequencies** are located in the upper left corner of the page, instead of across the top line as on other pages. The top frequency is the active frequency, with the standby frequency directly below.

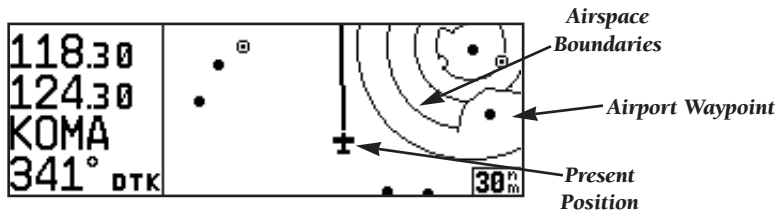

The **map display** occupies the right side of the display. Your present position is indicated by a plane symbol (in track up mode) or a position diamond (in other orientation modes), with your route displayed as a solid line. Nearby airports, nav aids and user waypoints may be depicted on the map; with unique identifying symbols for each waypoint type. Boundaries for special use and controlled airspaces can also appear on the map display. You may select which features are shown on the map using the map setup page (see page 101).

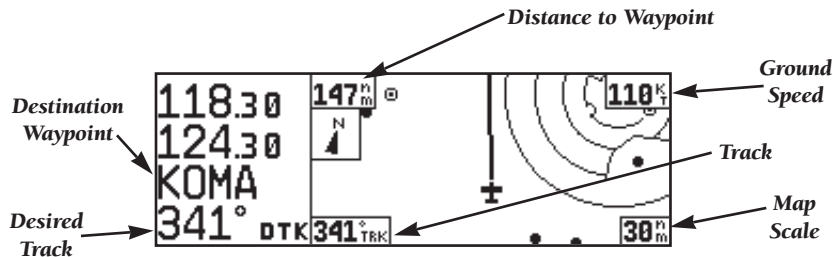

The **data fields** on the map page indicate distance to destination waypoint, desired track, ground track, ground speed and map scale. The destination waypoint name and desired track appear on the left side of the page, below the communication frequencies. The other data fields are located at the corners of the map display as shown in the illustration above, and may be removed by pressing **CLR**.

TAKEOFF TOUR

Map Page

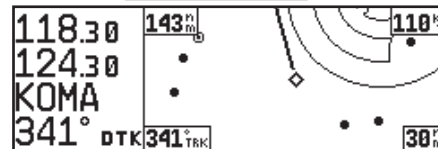

The map display may be oriented along your ground track (track up), course (desired track up) or fixed at north up. Desired track up or north up settings show your present position with a diamond symbol instead of the airplane symbol.

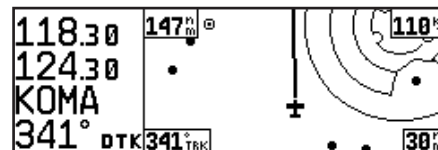

Communication frequencies are shown in the top left corner of the map page, instead of across the top line as shown on other GNC 300XL screens.

TAKEOFF TOUR

Map Scales NAVCOM Page

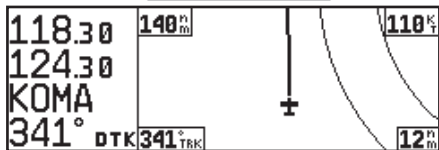

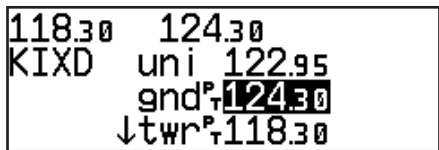

To change the map scale rotate the  knob clockwise to increase the scale or counterclockwise to decrease the scale.



The NAVCOM page lists the frequencies for your departure and arrival airports. To place a frequency from this list on standby, highlight the desired frequency and press .

The map display has 14 available ranges from 0.5 to 300 (nautical miles, statute miles or kilometers) representing the vertical height of the map. The map scale is controlled by the inner knob () , with the current scale displayed in the lower right corner of the page.

To select a map scale:



1. Rotate the  knob clockwise to increase the map scale and show a larger area.
2. Rotate the  knob counterclockwise to decrease the map scale and show a smaller area.

Another page available under the GNC 300XIs  key is the **navigation communications (NAVCOM) page**. It provides you with a complete list of airport frequencies at your departure and arrival airports, allowing convenient selection of frequencies you'll need along your flight path. If you do not have an active departure airport, the navigation communications page will display the frequencies for the airport nearest your departure position.

To view the NAVCOM page from the map page, rotate one stop to the right.

The NAVCOM page lists your departure and arrival airports on the left side of the page, with all the database frequencies listed in a column down the right side of the page. To scroll through the list of frequencies, simply rotate the inner knob () in the direction of the arrow prompts at the bottom left of the page.

To place a frequency from the list in the standby field:

1. Press the  key twice to activate the cursor in the GPS window.
2. Use the  knob to select the desired frequency. Press  to place the frequency in the standby field. The cursor will automatically advance to the next frequency on the list.

Once a direct-to is activated, the CDI page will provide navigation to the destination until the direct-to is cancelled or another direct-to destination is activated.

To cancel a direct-to from the CDI page:

1. Press the **CRSR** key twice to activate the cursor in the destination field.
2. Press **CLR**.
3. Press **ENT**.

The GNC 300XLs **NRST** key provides the nine nearest airports, VORs, NDBs, intersections, user waypoints and any SUA (special use airspace) alerts, as well as the two closest FSS (Flight Service Station) and center (ARTCC) frequencies for your present position. The nearest waypoint feature is a handy safety feature that may be used to execute a quick direct-to in case of an in-flight emergency or to review the closest facilities to your present position. The nearest feature can also be used to quickly find the contact frequency of the nearest airport and enter it in the standby field.

To view the nine nearest airports:

1. Press the **NRST** key. The nearest airport will be displayed, with the range and bearing from your present position, along with elevation, frequency and runway data.
2. To review the rest of the nearest airport list, rotate the **◉** knob to the right.

To place a nearest airport frequency in the standby field:

1. Press **ENT**. Press the **◀ ▶** key to place the frequency in the active field.

To view the nearest list for other waypoint categories (VOR, NDB, etc.):

1. Rotate the **◉** knob to the right, or press the **NRST** key repeatedly.
2. Rotate **◉** to scroll through the list.



| | | | |
|---------|-------------------|-------------------|--------|
| 118.30 | 124.30 | | |
| nr1 apt | KTOP | 880 ^f | |
| 273° | 8.12 ^M | twr | 118.70 |
| rnwy | 13 /31 | 5000 ^f | |

The nearest airport page shows up to nine nearest airports from your present position. To view additional nearest airports, rotate the **◉** knob.

| | | | |
|---------|-------------------|-------------------|--------|
| 118.30 | 118.70 | | |
| nr1 apt | KTOP | 880 ^f | |
| 273° | 8.12 ^M | twr | 118.70 |
| rnwy | 13 /31 | 5000 ^f | |

Additional frequencies may be displayed by pressing **CRSR** twice and rotating the **◉** knob (or press **CLR** repeatedly with the cursor inactive). To place a nearest airport frequency in the standby field, press **ENT**.

TAKEOFF TOUR

Nearest Airports Shutting Down

```
118.30 118.70
nr2 apt KFOE 1080f
234° 11.7m twr 120.80
rnwy 13 /31 12800f
```

To review a nearest waypoint, highlight the identifier and press **ENT**.

```
118.30 118.70
nr2 apt KFOE 1080f
234° 11.7m twr 120.80
rnwy 13 /31 12800f
```

To select a nearest waypoint as a direct to destination, press **-B>** and **ENT**.

Once the nearest airport (or any other nearest waypoint) page is displayed, the selected waypoint can be quickly reviewed or selected as a direct-to destination.

To review the selected waypoint from the nearest waypoint list:

1. Press **CRSR** twice to activate the waypoint field.
2. Press **ENT** to display the waypoint identification page.
3. Rotate **○** to view any additional waypoint information available.
4. Press **NRST** to return to the nearest waypoint page.

To select a nearest waypoint as a direct-to destination:

1. Press the **-B>** key. The direct-to confirmation page for the selected waypoint will appear.
2. Press **ENT** to confirm.

Congratulations! You've covered the basic operation of the GNC 300XL. We encourage you to experiment with your new GPSCOM to get to know all the advanced navigation features it has to offer. If you'd like a little more practice, try using the built-in simulator described in Appendix C. An optional AC adapter will even let you plan and simulate flights in the comfort of your home or office.

To turn the GNC 300XL off:

1. Turn the **○** knob to the left until the unit shuts off.

NOTE: The GNC 300XL is normally connected to power through the avionics master switch. With the optional remote battery installed, the unit will display a power down warning when the master switch is turned off. This warning page features a timer which will count down from 30 seconds when the unit senses that power is off. After 30 seconds, the GNC 300XL will shut off. If you wish to continue operating the unit, press any key during the countdown period, and the unit will operate from the battery.

Section 1

Navigation Key

The GNC 300XL features seven navigation pages to provide various position, course, speed, status and planning information. The pages may be viewed by pressing the **NAV** key and rotating the outer knob, or by pressing the **NAV** key repeatedly.

CDI page

```
118.30 124.30
+++++↑++++ gs :110°
dis 141.72 dtk 341°
go to:KOMA ete 1:17
```

Map page

```
118.30 124.30
147°
118.30
KOMA
341° dtk 341.70
```



NAVCOM page

```
118.30 124.30
KIXD uni 122.95
gnd 124.30
↓trw 118.30
```

NAV Menu 2

```
118.30 124.30
Appr Time? Clock?
Trip Time? RAIM Prd?
Scheduler? Sunrise?
```



Position page

```
118.30 124.30
alt 1911'
N38° 51.245' W094° 55.473'
frapt KIXD 305° 2.110'
```

```
118.30 124.30
Trip Plan? Dalt/tas?
Fuel Plan? Winds?
Vnav Plan? Chklist?
```

NAV Menu 1

```
118.30 124.30
3D Nav dop 2.0
sat 1 3 5 6 9 13 17 19
sgl 9 6 - 3 - 7 9 -
```

Satellite status page

The **CDI**, **map**, **NAVCOM** and **position** pages are the primary pages used during in-flight navigation, while the nav menu and status pages offer access to planning, calculation and status functions. Note that rotating the outer knob clockwise will continuously cycle through all the navigation pages, whereas turning the knob counterclockwise will stop the page selection sequence at the CDI page.

Whenever the **NAV** key pages are in use, the indicator light (D) next to the **NAV** key will illuminate. If the GNC 300XL requires you to enter data on a navigation page, a message prompt with specific instructions will appear and the indicator will flash. If you leave the NAV page sequence for another set of pages, the last NAV page displayed will reappear when you return to the nav sequence.

NAV KEY
Overview

SECTION
1

```
118.30 124.30
3D Nav dop 2.0
sat 1 3 5 6 9 13 17 19
sgl 9 6 - 3 - 7 9 -
```

Remember! The NAV pages will only display information **AFTER** the position and navigational information has been calculated from the satellites. If you are on the position page before the unit has calculated a position, you will be able to enter an approximate position and altitude. This is helpful in speeding satellite acquisition if the unit has moved a great distance with the power off.

If you are not sure the GPS is actively calculating position, check the receiver status field for '2D NAV' or '3D NAV' by pressing the **NAV** key and rotating the outer knob until the satellite status page appears. The current receiver status is displayed at the top left of the page.

SECTION

1

NAV KEY

CDI Page

```

132.10  120.10
+++++↓+++++ gs : 130KT
dis  0.40n  trk 340°
go to: KOMA  ete__:_
    
```

The TO/FROM arrow indicates whether you are heading to (an up arrow) the waypoint or if you've passed the waypoint (a down arrow).

```

118.30  124.30
No actv wpt gs : 110KT
dis  _____n  brg  ___°
_____→_____ ete__:_
    
```

'No active waypoint' appears on the CDI field if there is no destination waypoint selected using the **→** key and no active route.

The GNC 300XL's **CDI page** provides you with the important information needed to navigate directly to your destination. The destination field, located at the bottom left of the page, displays the current destination waypoint or active route leg being navigated. If no direct-to destination, route or approach is being navigated, the destination field will remain blank.

The diagram shows the CDI page with the following fields labeled:

- Messages or CDI:** Points to the top line of the display showing the current and next waypoint numbers (118.30 and 124.30).
- Distance Field:** Points to the 'dis' field showing the distance to the next waypoint (141.72ⁿ).
- Ground Speed:** Points to the 'gs' field showing ground speed (110^K_T).
- Direction Field:** Points to the 'dtk' field showing the desired track (341°).
- Active Waypoint:** Points to the 'go to' field showing the active destination (KOMA).
- Time or Direction Field:** Points to the 'ete' field showing the estimated time en route (1:17).

The **graphical CDI** (course deviation indicator) at the top left of the page shows your position relative to the desired course (the moving D-bar) to the destination waypoint. The **TO/FROM arrow** in the center of the scale indicates whether you are heading to (an up arrow) the waypoint or if you have passed the waypoint (a down arrow). Note that the GNC 300XL always navigates TO a waypoint unless the GPS SEQ switch is set to the HOLD position, or you have passed the last waypoint in a route. The default setting of the CDI scale is 'auto'. If you are not navigating to a destination, the CDI field will display a 'no actv wpt' message, and only speed and track data will be available. The CDI field is also used to display the GNC 300XL's turn anticipation and waypoint alert data during route operations (see Section 5).

In addition to displaying your active destination and the course deviation scale, the CDI page features four selectable fields for various distance, direction and time options. This allows you to configure the CDI page to your preferences. The default settings are ground speed, distance, desired track and estimated time en route.

The following functions may be displayed in the ground speed field:

- **gs**— Your present speed over the ground.
- **str**— Steer direction and distance, or digital crosstrack error. An 'L' or 'R' indicates which direction to steer, while the distance value indicates how far you are off course.

The following functions may be displayed in the distance field:

- **dis**— Distance from present position to the 'active to' waypoint.
- **str**— Steer direction and distance, or digital crosstrack error. An 'L' or 'R' indicates which direction to steer, while the distance value indicates how far you are off course.

The following steering functions may be displayed in the direction field:

- **brg**— Bearing, the direction from your present position to the waypoint.
- **cts**— Course to steer to reduce cross track error and re-intercept course.
- **dtk**— Desired track, the course between the active from and to waypoints.
- **trk**— Track, the direction of movement relative to the ground.
- **trn**— Turn, the direction and degrees to turn to get back on course.

The following information can be displayed in the time field:

- **eta**— Estimated Time of Arrival (at the active to waypoint).
- **ete**— Estimated Time En route (to the active to waypoint).
- **trk**— Track, or the direction of movement relative to the ground.
- **vn**— Vertical Navigation, or VNAV. If VNAV has been activated, this field indicates either the elapsed time before the VNAV maneuver is to begin or the VNAV altitude (the suggested altitude you should be flying in order to complete the maneuver).

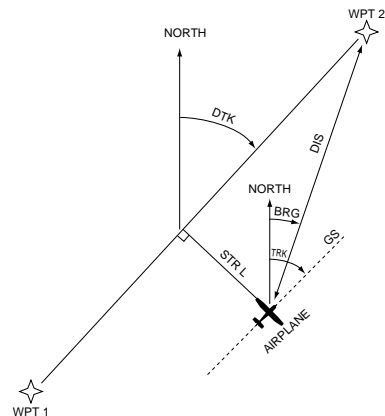

SECTION

1

NAV KEY

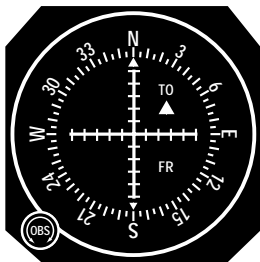
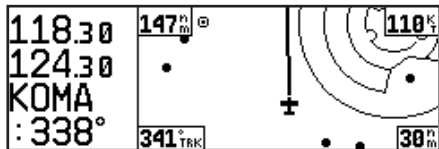

CDI & Course Select



GPS SEQ
HOLD

The GNC 300XL's course select feature uses the external GPS SEQ switch, allowing you to dial in the desired course to or from your destination directly from your HSI.

To change any of the selectable fields on the CDI page:

1. Press **CRSR** twice to activate the cursor in the GPS window.
2. Rotate  to highlight the field you would like to change.
3. Rotate  to change the field to display the desired information.
4. Rotate  to highlight another field, or **CRSR** to finish.

Destination

Selected
Course

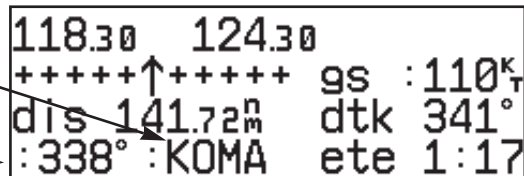

The GNC 300XL's **course select feature** allows the pilot to define the inbound course to, or outbound course from, the 'active' waypoint, using an external HSI. Once the course select function is activated, the selected course will be displayed next to the destination waypoint identifier and the CDI will provide guidance relative to the desired course. The course select feature is only available during route, approach or direct-to navigation. For more information on the course select feature and the GPS SEQ switch, see Section 6.

To set a desired inbound course:

1. Dial the desired course on the HSI.
2. Set the external GPS SEQ switch to the HOLD position.
3. To stop the course select function, set the GPS SEQ switch back to the AUTO position.

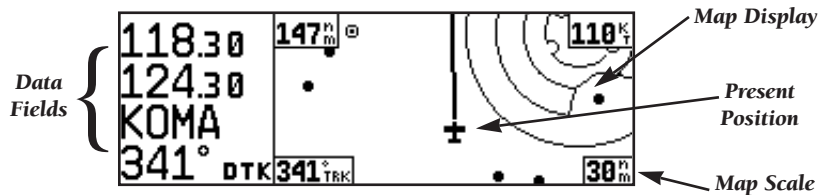

The next page available from the GNC 300XLs **NAV** key is the **map page**. The map page displays your present position, using an airplane symbol (in track up mode) or a position diamond (in other orientation modes), along with nearby airports, VORs, NDBs, intersections, user waypoints and airspace boundaries. **Note:** If the GNC 300XL is unable to determine a GPS position the present position symbol will not appear on the map page.

The top left corner of the page indicates the active and standby communications frequencies — unlike other GNC 300XL screens which display both frequencies across the top line — with the active frequency on top.

The map display occupies the right side of the display and shows your position relative to nearby airports, nav aids, user waypoints and airspaces. Different symbols are used to distinguish between waypoint types. The identifiers for any on-screen waypoints can also be displayed. Special-use and controlled airspace boundaries appear on the map, showing the individual sectors in the case of Class B or Class C airspace. The map display can be configured to display airports, nav aids, user waypoints, airspaces only at certain scales or these items may be disabled entirely (see page 100). This allows you to de-clutter the map display at larger scale settings.

The map display can be set to 14 different scale settings from 0.5 to 300 (nautical miles, statute miles or kilometers) during en route operation; while in terminal or approach mode 12 different scale settings are available (with the two highest en route scales disabled). The scale represents the top-to-bottom distance covered by the map display.

NAV KEY SECTION 1

Map Page

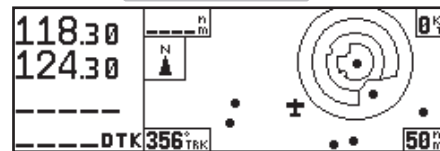

The map page, showing only airports and airspaces on the map display.

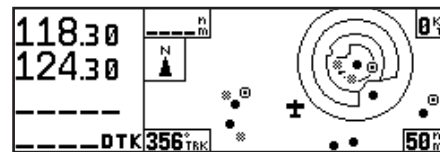

The map page, showing airports, airspaces, VORs and NDBs on the map display. The data fields located at the corners of the map display may be removed by pressing **CLR**.

SECTION

1

NAV KEY

Map Page

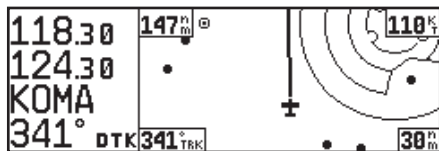

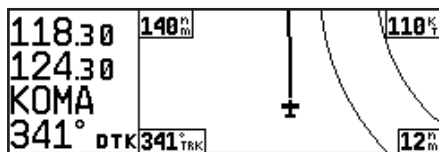

On the map page the active and standby communication frequencies are in the upper left corner of the page. The active frequency is on top.



To change the map scale rotate the  knob clockwise to increase the scale or counterclockwise to decrease the scale.

To select a map scale:

1. Rotate the  knob clockwise to increase the map scale and show a larger area.
2. Rotate the  knob counterclockwise to decrease the map scale and show a smaller area.

An autozoom feature is available which will automatically adjust from an en route scale of 300 through each lower scale, stopping at a scale of 1 as you approach your destination waypoint. The autozoom feature is turned on/off from the map setup page described on page 101.

The orientation of the map may be fixed at 'north up', or set to 'desired track up' (dtk up) or 'track up' (trk up). The 'north up' setting will keep the top of the map display fixed on north. 'Track up' will cause the map to rotate so the top of the map is the direction you are heading. 'Desired track up' keeps the map display fixed along your desired course. Map orientation is changed on the map setup page described on page 101.

Navigation data is also provided on the map page to guide you during your flight. The destination waypoint name and desired track (dtk) appear on the left side of the page, below the communication frequencies. Four additional data fields are located at the corners of the map display (and may be removed by pressing ) , as follows:

- | | |
|----------------------------|--|
| Distance (dis) to waypoint | - upper left corner |
| Ground speed (gs) | - upper right corner |
| Ground track (trk) | - lower left corner |
| Map scale | - lower right corner (cannot be removed) |

```

118.30 124.30
KIXD uni 122.95
      gndP 124.30
      ↓twrP 118.30

```

The next page available from the GNC 300XL's **NAV** key is the **navigation communications (NAVCOM) page**. The NAVCOM page provides a list of the airport frequencies at your departure and arrival airports, allowing convenient selection of frequencies you'll need along your flight path. To scroll through the list of frequencies, rotate the inner knob (●) in the direction of the arrow prompts at the bottom left of the page.

The frequencies displayed for the departure and arrival airports are listed in the order you are most likely to use them (see right), with the available frequencies displayed to the right of the airport identifier. If you do not have an active route with a departure airport, the NAVCOM page will display the frequencies for the airport nearest your departure position.

If a frequency has sector or altitude restrictions, the frequency will be followed by a 'brg?' indication.

To view restrictions on a frequency:

1. Press **CRSR** twice to activate the cursor in the GPS window.
2. Rotate ● to highlight the 'brg?' next to the frequency you wish to view.
3. Press **ENT** to begin viewing restrictions.

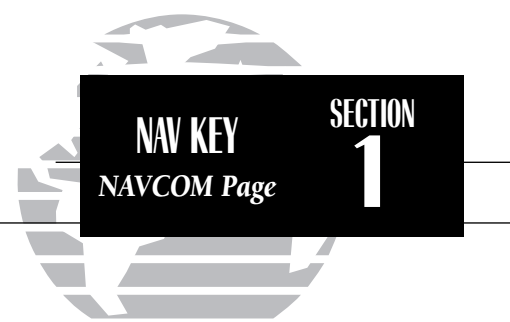

```

125.15 121.90
KICT uni 122.95
      ats 125.15
      ↓clr 125.70

```

The NAVCOM page lists the frequencies for your departure (or nearest) and arrival airports in the following order:

Departure

- Unicom
- ATIS
- Clearance Delivery
- Clearance Pretaxi
- Ground
- Tower
- Multicom
- Other
- Departure
- TCA
- TMA
- CTA
- ARSA
- TRSA

Arrival

- ATIS
- Approach
- Arrival
- TCA
- TMA
- CTA
- ARSA
- TRSA
- Tower
- Multicom
- Other
- Ground
- Unicom

SECTION

1

NAV KEY
NAVCOM &
Position Pages

```

121.90 120.30
KACY c/c 124.60 brg?
      c/c 134.25 brg?
KCLT ↕ats 121.15x

```



NAVCOM page with receive only (rx) frequencies and frequencies with restrictions (brg).

```

121.90 120.30
KACY↕ class C 124.60
130-309°

```



Frequency restrictions on 124.60, showing range of applicable radials from 130° through 309°.

Once you begin viewing restrictions, you can view any additional frequencies for the selected airport by rotating . (Note: An arrow prompt displayed next to the airport identifier indicates additional frequencies are available.) You can also view the other airport information pages by rotating . Information contained on these pages is covered in Section 3. To return to the NAVCOM page, press .

Some frequencies in the NAVCOM page have tags which designate their usage:

'tx' – transmit only 'rx' – receive only
'pt' – part time frequency

To make any of the frequencies on the NAVCOM page the standby frequency:

1. Press  twice to activate the cursor in the GPS window.
2. Rotate  until the desired frequency is highlighted.
3. Press  to make the highlighted frequency the standby frequency. The cursor will automatically advance to the next frequency on the list.

The GNC 300XL **position page** displays your present latitude and longitude, altitude and a reference waypoint field. The altitude and reference waypoint fields are selectable to configure the page to your own preferences and current navigation needs.

Altitude, MSA
or ESA

Position (lat/lon)

```

121.90 120.30
alt 1082f prs: 30.03m
N39° 12.930' W094° 39.649'
frapt KMCI 150° 5.51m

```

Altimeter Setting
Field
(user-selectable)

Reference Waypoint Field

An altimeter setting field appears on the position page when you are within 30 nm of a destination airport. The altimeter setting field allows you to define the current barometric pressure, which is used by the integrity monitoring to cross check altitude.

The altitude field can display either the present altitude, minimum safe altitude (MSA) or en route safe altitude (ESA). MSA is the recommended minimum altitude within a ten mile radius of your present position. ESA is the recommended minimum altitude within a ten mile radius of your course on an active route or direct-to. MSA and ESA altitudes are calculated from information contained in the database and generally include mountains, buildings and other permanent features (see right).

To change the altitude field:

1. Press **CRSR** twice to obtain a cursor in the GPS window.
2. Rotate **○** until the 'alt/ESA/MSA' field is highlighted.
3. Rotate **●** to display the desired data. Press **CRSR** to return to normal navigation.

The position page also features a **reference waypoint field**, located at the bottom of the page, to indicate your bearing and distance from a selected waypoint. The reference waypoint field can display the following:

- Range, bearing and identifier from the nearest airport (default), VOR, NDB, intersection, or user waypoint
- Range, bearing, and identifier from a user specified waypoint

The default setting is to display the nearest airport. During DME arc approach operations, the reference field will automatically display the DME reference as long as the 'active' waypoint is part of the DME arc.

To change the reference waypoint field to display the nearest airport, VOR, NDB, intersection, user waypoint or the range and bearing from a user selected waypoint:

1. Press **CRSR** twice to activate the cursor in the GPS window.
2. Rotate **○** to highlight the category field after the **f**.

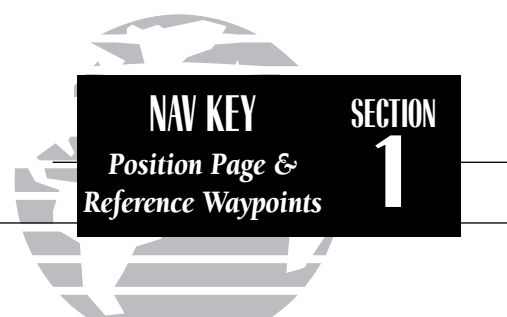

```

118.30 124.30
msa 3700f
N38° 56.118' W094° 55.320'
fapt KIXD 342° 6.41M
    
```

Position page displaying MSA. MSA and ESA are based on data stored in the NavData card. This information cannot be solely relied upon as an absolute measure of safe altitude in your area. Consult current charts and NOTAMS.

```

118.30 124.30
esa 4200f
N38° 56.118' W094° 55.320'
fapt KIXD 342° 6.41M
    
```

The same position page displaying ESA.

SECTION

1

NAV KEY

Reference Waypoints
& Satellite Status

```

118.30 124.30
alt: 1911ft
N38° 51.245' W094° 55.473'
frwpt: TOP 115° 33.78M

```

Position page displaying 'TOP' VOR as the reference waypoint. This configuration can be used to help monitor your distance and radial from a waypoint of your choice. (NOTE: The waypoint category is listed as 'wpt' rather than 'vor' because the GNC 300XL is not using the nearest VOR.)

```

118.30 124.30
3D Nav epe 119ft
sat 1 3 5 6 9 13 17 19→
sgl 9 6 - 3 - 7 9 -

```



Satellite status page with 'EPE' displayed. Estimated Position Error (EPE) gives an overall measure of your position accuracy in feet or meters.

3. Use  to choose which waypoint type you would like displayed. (Choose 'wpt' if you would like range and bearing from a specific waypoint to be displayed.)

4. Press  to remove the cursor, or:

If you have selected 'wpt':

5. Rotate  to advance the cursor to highlight the identifier field.

6. Use the  and  knobs to enter the identifier name. (This waypoint identifier can be an airport, VOR, NDB, intersection, or user waypoint.) Press .

7. Press  to confirm the selection.

This allows the distance and bearing from any waypoint to be displayed continuously, which may be useful when an approach reference is not the closest navaid.

The GNC 300XL's **satellite status page** provides satellite information to monitor GPS coverage and receiver performance. This is helpful when you may be experiencing low signal levels due to poor coverage or installation problems.

To view the satellite status page:

1. Press  and rotate  until the satellite status page appears.

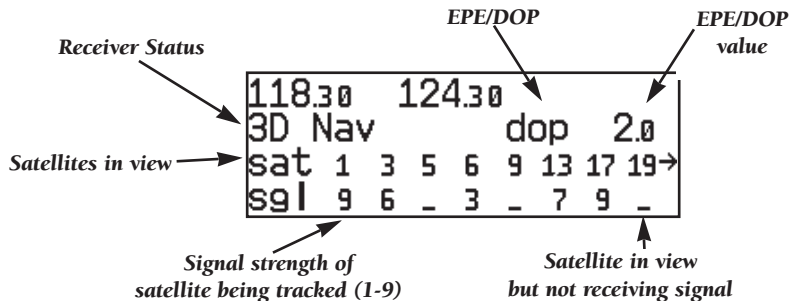

The top lines of the status page display active and standby frequencies, followed by the receiver status and the current position accuracy in DOP or EPE. The default setting is DOP. The following functions may be displayed in the DOP/EPE field:

- **dop**— Dilution of Precision, a measure of the satellite geometry quality and relative accuracy of your position, with 1 indicating good geometry and 10 indicating poor.
- **epe**— Estimated Position Error, an overall measure of your positional accuracy in feet or meters using signal and data quality, receiver tracking status and DOP.

To change the DOP/EPE field:

1. Press **NAV** and rotate **⊙** to display the satellite status page.
2. If the desired field (EPE or DOP) is not displayed, press **CRSR** twice.
3. Use **⊙** to change between 'epe' and 'dop'. Press **CRSR** to finish.

The **receiver status field**, located at the top left of the page, will display the following messages under the appropriate conditions:

Search Sky - The GNC 300XL is searching the sky for visible satellites. You will be informed with the message 'Searching the Sky'.

Acquiring - The GNC 300XL is acquiring satellites for navigation.

2D Nav - The GNC 300XL is in 2D navigation mode. If your installation does not include an altitude serializer, you must enter the altitude manually (see page 2). '2D Dif Nav' will appear when you are receiving DGPS corrections in 2D mode.

3D Nav - The GNC 300XL is in 3D navigation mode and will compute altitude. '3D Dif Nav' will appear when you are receiving DGPS corrections in 3D mode.

Simulator - The GNC 300XL is in simulator mode, which should only be used for practice and trip planning. **Never** use simulator mode for actual navigation.

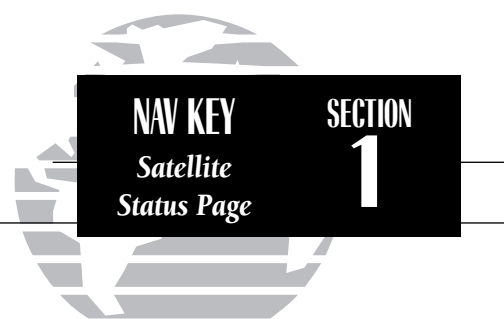

```

118.30 124.30
3D Nav dop 2.0
sat 1 3 5 6 9 13 17 19→
sgl 9 6 - 3 - 7 9 -
  
```

Satellite status page with 'DOP' displayed. Dilution of Precision (DOP) measures relative accuracy from 1 to 10.

```

122.80 118.30
Acquiring epe____f_T
sat 1 3 5 6 9 13 17 19→
sgl 9 6 - 3 - 7 9 -
  
```

'Acquiring' satellites for navigation. In this case, the satellites are being received, but the data is still being collected before a position can be determined.

SECTION

1

NAV KEY

Receiver Status &
Satellite Data

```
122.80 118.30
Search Sky epe____f
sat 1
sgl -
```

'Searching the Sky' for satellites. No satellite almanac data exists in the GNC 300XL. It must be recollected from the first available satellite.

```
136.97 118.00
Satellite 5
elev 03°↓ ura 26f
azm 018° sgl -
```

Viewing individual satellite information.

- Poor Cvrge-** The GNC 300XL cannot acquire sufficient satellites for navigation.
- Need Alt -** The GNC 300XL needs altitude in order to start/continue navigation. Press **NAV** to display the position page and enter the altitude.
- Not Usable -** The GNC 300XL is unusable due to incorrect initialization or abnormal satellite conditions. Turn the unit off and on again.
- Autolocate -** The GNC 300XL is looking for any satellite whose almanac has been collected. This process can take up to five minutes.

The third and fourth lines of the satellite status page provide the satellite number and signal strength of each satellite in view. The satellite status page shows signal strength for up to eight satellites at a time. If additional satellites are being received an arrow on the 'sat' line will indicate additional data is available.

To view additional satellites:

1. Rotate **⬇** to view more satellites.

Additional information regarding each satellite's azimuth, elevation and other data is also available.

To view individual satellite information:

1. Press **NAV** and use **⬇** to display the satellite status page.
2. Press **CRSR** twice to activate the cursor in the GPS window.
3. Use **⬇** to highlight the satellite number you wish to view and press **ENT**. This will display the satellite data page, showing the selected satellite's number, elevation angle, rise or fall indication, User Range Accuracy (URA, or the range measurement accuracy as determined by the satellite), azimuth and signal strength.
4. Rotate **⬇** to view information for the next satellite.
5. Rotate **⬇** and press **CRSR** on the satellite status page when you are finished.

In addition to the other five pages, the GNC 300XL features two menu pages to perform a host of planning and navigation functions. **NAV Menu 1** provides access to the following functions:

- **Trip Planning**
- **Fuel Planning**
- **VNAV Planning**
- **Density altitude/true airspeed calc.**
- **Winds aloft calculations**
- **Checklists**

To display NAV Menu 1:

1. Press **NAV**.
2. Rotate **○** until NAV Menu 1 is displayed.

Trip Plan is the first function listed on NAV Menu 1 and allows the pilot to view distance, ESA, bearing and estimated time en route (ETE) between any two waypoints, and for programmed route legs. The ground speed can be varied manually to calculate several possible ETEs.

To use the trip planning function:

1. Press **NAV** and rotate **○** until NAV Menu 1 is displayed.
2. Press **CRSR** twice, then **ENT** to access trip planning.
3. Rotate **●** to select waypoint mode or desired route number and press **ENT**.
4. For direct-to navigation, use **●** and **○** to enter the 'to' and 'from' waypoints. Press **ENT** to accept the waypoints. To use your present position as a waypoint, leave the waypoint field blank.
5. For route calculations, choose either 'cum' for cumulative data (from beginning to end) or the leg desired by rotating **●**.
6. Use **●** and **○** to enter the ground speed. Press **ENT** to calculate the values and **CRSR** to finish.

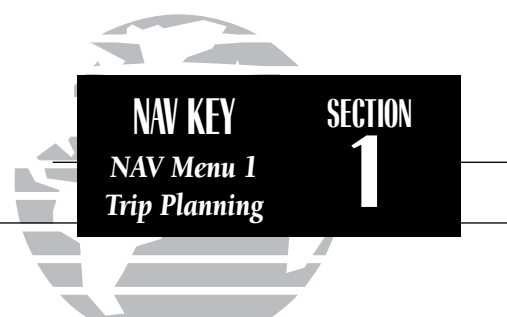

```
118.30 124.30
Trip Plan? Dalt/tas?
Fuel Plan? Winds?
Vnav Plan? Chklist?
```

NAV Menu 1

```
118.30 124.30
wpt: KIXD →KTCS
240° 688.61N gs: 120K
esa 14400F ete 5:44
```

Trip planning with values calculated between two waypoints.

SECTION

1

NAV KEY

Density Altitude &
True Airspeed

```

118.30 124.30
ialt: 1300FT cas: 110KT
pres: 29.95H9 tat: 68OF
dalt 2000FT tas 113KT

```

Density altitude/true airspeed page

```











118.30 124.30
wpt: ----->KDAL
fob: 36L flow: 10.0L
rng 504.0M rsv 0:56

```

Fuel planning page showing calculation from present position to 'KDAL'.

The **density altitude/true airspeed function** is also accessed from NAV Menu 1. Density altitude is the theoretical altitude at which your aircraft will perform depending on several environmental conditions, including air pressure and total air temperature (the temperature including the heating effect of speed, read on a standard outside temperature gauge on most aircraft). True airspeed considers the same factors.

To calculate the density altitude and true air speed:

1. Press **NAV** and rotate  until NAV Menu 1 is displayed.
2. Press **CRSR** twice and rotate  to highlight 'Dalt/tas?'.

3. Press **ENT** to access the density altitude page.
4. Use  and  to enter the indicated altitude ('ialt') and press **ENT**.
5. Use  and  to enter the calibrated airspeed ('cas'). Press **ENT**.
6. Use  and  to enter the air pressure ('pres') and press **ENT**.
7. Use  and  to enter the total air temperature ('tat').
8. Press **ENT** and the density altitude and true airspeed will be calculated and displayed.
9. Press **CRSR** to remove the cursor.

If your installation includes components to provide any of the information required on the density altitude page, they will be used as the defaults.

The **fuel planning** page will display fuel requirements for both direct-to navigation and programmed routes. The fuel planning function requires the pilot to enter the initial amount of fuel on board and the flow rate. You may also enter different ground speeds to view various information based on different travel times. If your installation is interfaced to a fuel flow sensor, the flow rate and other information will be supplied by the fuel flow sensor, and need not be entered manually.

To perform fuel planning operations:

1. Press **NAV** and rotate **○** until NAV Menu 1 is displayed.
2. Press **CRSR** twice and rotate **○** until 'Fuel Plan?' is highlighted. Press **ENT**.
3. Rotate **●** to select either 'wpt' for direct navigation or the desired route number. Press **ENT**.
4. For waypoint-waypoint navigation, use **●** and **○** to enter the 'to' and 'from' waypoints. Press **ENT** to accept the waypoints. To use the present position as a waypoint, leave the corresponding waypoint field blank.
5. For route calculations, choose either 'cum' for cumulative route fuel requirements (from beginning to end) or the leg desired by rotating **●**.

If leg is selected, it displays the amount of fuel required to fly until that leg is complete.

For example: The fuel required to complete leg 2 is leg 1 + leg 2.
Fuel required to complete leg 4 is leg 1 + leg 2 + leg 3 + leg 4.

6. Rotate **○** to advance the cursor to 'fob.' or 'gs.' (depending on which is displayed).
7. Use **●** and **○** to enter the fuel on board or the ground speed. Press **ENT**.
8. Rotate **○** back two positions to highlight the 'fob.' or 'gs.' field again.
9. Rotate **●** to display the other information. Press **ENT**.
10. Use **●** and **○** to enter the remaining data. Press **ENT**.
11. Use **●** and **○** to enter the flow rate, in units per hour, if needed. Press **ENT**.

The GNC 300XL will calculate the range and endurance (i.e., how long the fuel will last) of your aircraft. These are found in the first field on the bottom row of the page. The amount of fuel left on board (lfob) and reserve time after the selected direct-to, leg or route is flown are displayed in the second field on the bottom row.

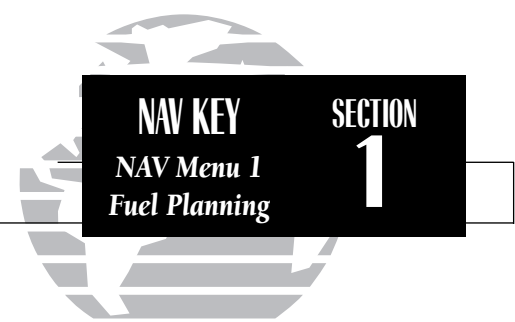

```
118.30 124.30
wpt:      KICT →KDFW
gs: 140k flow: 10.0l
rng 504.0m lfob 16l
```

Fuel planning page showing calculations between two waypoints.

```
118.30 124.30
wpt:      KICT →KDFW
fob: 36l flow: 10.0l
endur 3:36 rsv 1:33
```

Fuel planning page with other information indicating 'endurance' and 'reserve' times.

SECTION

1

NAV KEY

Winds Aloft &
VNAV Functions

```
118.30 124.30
hdg: 349° tas: 140kT
wind fr: 037° at 31kT
head wind is 20kT
```







Winds aloft page

```
118.30 124.30
fr: 6500fT to: 2000fT
by: 5.0m before KOMA
at: 400fpm activate?
```

Vertical navigation page











The GNC 300XIs **winds aloft function** is used to calculate the true direction and speed of any winds, and indicates whether you are flying with a head wind or tail wind, and the wind speed.

To calculate winds aloft:

1. Press **NAV** and rotate  until NAV Menu 1 is displayed.
2. Press **CRSR** twice and rotate  until 'Winds?' is highlighted. Press **ENT**.
3. Use  and  to enter your present heading in the 'hdg:' field. If your installation includes a fuel/air data computer, this will be displayed automatically. Press **ENT**.
4. Use  and  to enter your true airspeed (TAS) in the 'tas:' field. If you have previously calculated it using the density altitude/true air speed function, it will be displayed as the default. Press **ENT**. The wind direction and speed and head/tail wind will be displayed.

The **VNAV function** calculates vertical speed requirements to reach a desired altitude before or after a specified distance from a waypoint. This is helpful when you'd like to descend to a certain altitude near an airport or climb to an altitude before reaching a route or direct-to waypoint.

To calculate vertical navigation parameters:

1. Press **NAV** and rotate  until NAV Menu 1 is displayed.
2. Press **CRSR** twice and rotate  until 'Vnav Plan?' is highlighted. Press **ENT**.
3. Use  and  to enter the initial (from) altitude. Your current GPS altitude will be displayed as the default. Press **ENT**.
4. Use  and  to enter the desired final (to) altitude. Press **ENT**.
5. Use  and  to enter the distance from the waypoint. Press **ENT**.
6. Use  to select 'before' or 'after' the waypoint. Press **ENT**.
7. Use  and  to select the waypoint identifier (it must be a waypoint in the active route or a direct-to waypoint). Press **ENT**.

You will now notice that the vertical speed has been calculated, based on your present speed. If you desire a more rapid climb or descent rate:

8. Use **▲** and **▼** to enter the new desired vertical speed, or press **ENT** to accept the calculated value.
9. Press **ENT** to activate the vertical navigation function.

If you enter a value greater than the value computed by the GNC 300XL, the time remaining before the maneuver is to begin will be displayed. When the countdown reaches 15 seconds, you will be informed with the message 'Start altitude chng'. The VNAV function will automatically be cancelled if the active direct-to or route is changed in any way, and you will be informed with a 'VNAV cancelled' message.

The GNC 300XL allows you to create up to nine **checklists** with 30 items each to remind you of repetitive tasks. These checklists can be called up at any time for review and are useful for creating pre-flight checklists, landing checklists, emergency procedures, etc. Each name or function can have up to 16 characters each.

To create a checklist:

1. Press **NAV** and rotate **▲** until NAV Menu 1 is displayed.
2. Press **CRSR** twice and rotate **▲** until 'Chklist?' is highlighted. Press **ENT**.
3. Press **CRSR** and use **▲** to highlight the checklist you would like to create or edit. Press **ENT**.
4. Use **▲** and **▼** to enter the title of the checklist. Press **ENT**.

This will display the checklist items page. On this page you can enter each task, such as 'Check Fuel'.

5. Use **▲** and **▼** to enter the checklist item. Press **ENT**.
6. You may repeat step 5 to enter additional items, or press **CRSR** to finish.



```
118.30 124.30
+++++↑++++ gs :150KT
dis 25.29M trk 338°
go to:KOMA vn 4800FT
```

VNAV displayed on CDI page. The VNAV altitude should be compared with the reading on the aircraft altimeter to ensure you are on the proper climb/descent profile.

```
118.30 124.30
Select check list
: PRE TAXI
↓ : EMERGENCY
```

Checklist catalog page.

SECTION

1

NAV KEY

Checklists
Approach Timer

```

118.30 124.30
EMERGENCY
✓ : THROTTLE CLOSED
↓ : MX_CTRL_IDL_CUTO
  
```

Executing a checklist.

```

118.30 124.30
Appr Time? Clock?
Trip Time? RAIM Prd?
Scheduler? Sunrise?
  
```

NAV Menu 2

To execute a checklist:

1. Press **NAV** and rotate **○** until NAV Menu 1 is displayed.
2. Press **CRSR** twice and rotate **○** until 'Chklist?' is highlighted. Press **ENT**.
3. Use **○** to highlight the checklist you would like to see. Press **ENT**.
4. Press **ENT** to check off list items.

To delete a checklist item or an entire checklist:

1. To delete a checklist item, highlight the desired item and press **CLR**, followed by **ENT**.
2. To delete an entire checklist, highlight the desired list and press **CLR**, followed by **ENT**.

The GNC 300Xi's **NAV Menu 2** provides access to various timer and planning functions, including:

- **Approach timer**
- **Trip Timer**
- **Scheduler messages**
- **Clock (Date and time)**
- **RAIM Prediction**
- **Sunrise and sunset calculations**

The **approach timer** acts as either a count up or a count down timer that can be set or reset at any time.







To activate/change/view the approach timer:

1. Press **NAV** and rotate **○** until NAV Menu 2 is displayed.
2. Press **CRSR** twice and rotate **○** until 'Appr Time?' is highlighted. Press **ENT**.
3. Rotate **●** to select either 'Count up' or 'Count down'. Press **ENT**.
4. Use **●** and **○** to set the time from which to begin counting. Press **ENT**.
5. Rotate **○** to select the desired function: 'Start', 'Stop', or 'Reset'. Press **ENT** to execute.

When the count down timer reaches zero, you will be informed with a 'Timer expired' message. The timer will then begin to count up, displaying the time since it expired. The timer runs, if not altered, whenever the GNC 300XL is turned on.



The GNC 300XL **clock function** keeps track of both UTC time (Greenwich Mean Time or Zulu Time calculated from the satellites) and local time, allowing you to designate which format to use for all time displays. The local time and date can be set without displaying local time on other GNC 300XL pages.

To set the local date/time:

1. Press **NAV** and rotate  until NAV Menu 2 is displayed.
2. Press **CRSR** twice and rotate  until 'Clock?' is highlighted. Press **ENT**.
3. Use  to select either 'utc' or 'local' time to be displayed in the time fields. Press **ENT**.
4. Use  and  to set the local date. Press **ENT**.
5. Use  and  to set the local time. Press **ENT**.
6. Press **CRSR** to complete.

The GNC 300XL's **trip timer** will automatically keep track of the duration of your current trip and can be configured to run either when the GNC 300XL is on, or when your ground speed exceeds a specified value (see Section 7).

To view or reset the trip timer:

1. Press **NAV** and rotate  until NAV Menu 2 is displayed.
2. Press **CRSR** twice and rotate  until 'Trip time?' is highlighted. Press **ENT**. The current time of day, departure time and time en route will be displayed.
3. To reset the timer, press **ENT**. To skip resetting the timer, press **CRSR**.

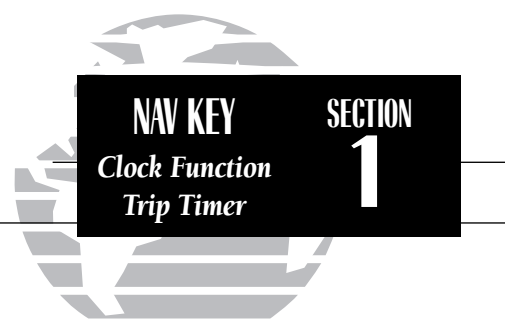
A rectangular LCD display showing the following text:

```
118.30 124.30
Select local (lcl)
25-nov-96 9:44:32 U
25-nov-96 3:44 lcl
```

Clock function set to display local time in the time fields of all other GNC 300XL pages.

A rectangular LCD display showing the following text:

```
118.30 124.30
Time 3:45
Dep 3:41
Trip 0:05 Reset?
```

*To reset the trip timer, highlight 'Reset?' and press **ENT**.*

SECTION

1

NAV KEY

RAIM Prediction

```
118.30 124.30
wpt:KICT
eta: 6:45 25-nov-96
Compute RAIM?
```









Enter the time and date for RAIM prediction.

```
118.30 124.30
wpt:KICT
eta: 6:45 25-nov-96
RAIM Available
```

RAIM available for the entered time, date and waypoint location.

The **RAIM Prediction function** allows you to confirm that GPS coverage is available for your current location or at a specified waypoint any day of the year. **Receiver Autonomous Integrity Monitoring** performs checks to ensure that the GNC 300XL will have adequate satellite geometry to work with during your flight. RAIM availability will be near 100% in Oceanic, En route and Terminal phases of flight. Because the FAA's TSO requirements for non-precision approaches specify significantly better satellite coverage than other flight phases, RAIM may not be available when flying some approaches. The GNC 300XL will automatically monitor RAIM during approach operations and warn you if RAIM is not available. RAIM prediction will help you plan for a pending flight to confirm GPS operation during an approach.







To predict RAIM availability:

1. Press **NAV** and rotate  until NAV Menu 2 is displayed.
2. Press **CRSR** twice and rotate  to highlight 'RAIM Prd?'. Press **ENT**.
3. Rotate  to highlight the field which you would like to change.
4. Use  and  to enter the waypoint name, or leave it blank to use your current position. Press **ENT** to accept.
5. Use  and  to enter the ETA in hours and minutes (in local or UTC time, whichever you have selected from the clock display), and the day, month and year. The current date will be displayed automatically. Press **ENT** to accept.
6. Rotate  to highlight 'Compute RAIM?'
7. Press **ENT** to compute information.

When the computations are complete, the GNC 300XL will display whether or not RAIM is available for the specified waypoint at the specified date and time, +/- 15 minutes of your ETA. Refer to the table on page 103 for specific RAIM protection limits as they relate to CDI scale figures.

The **scheduler function** will display reminder messages (such as ‘Change oil’, ‘Switch fuel tanks’, ‘Overhaul’, etc) after a specified time has elapsed. For example, if you enter ‘Change oil’ to be displayed in 30 hours, the message ‘Change oil’ will be displayed after the GNC 300XL has been running in Normal mode for 30 hours. After appearing, the message will be displayed each time the GNC 300XL is turned on until it is changed or deleted.

To enter a scheduled message:

1. Press **NAV** and rotate  to display NAV Menu 2.
2. Press **CRSR** twice and rotate  until ‘Scheduler?’ is highlighted.
3. Press **ENT**.
4. Rotate  to highlight the message you would like to edit. To delete, press **CLR**, then **ENT**.
5. Use  and  to enter the message. Press **ENT**.
6. Use  and  to set the time to elapse before the message is displayed, in hours and minutes, up to 99 hours and 59 minutes (this time is cumulative and counts whenever the GNC 300XL is on in normal operating mode).
7. Press **ENT**.

You may edit another scheduled message by repeating steps 4, 5, 6 and 7, or if you are finished, press **CRSR**.

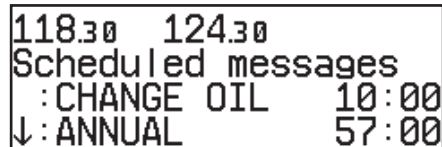
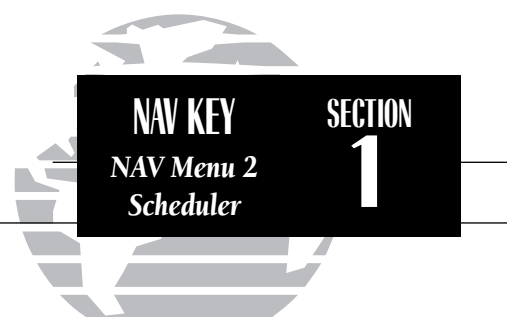

The scrolling arrow prompt indicates which direction to scroll to view additional listings.

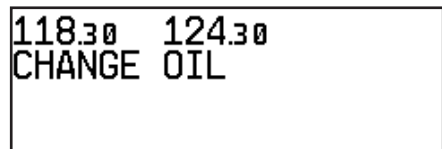

The scheduled message will appear after the timer expires and reappear every time the GNC 300XL is powered on until the message is changed.

SECTION

1

NAV KEY







Sunrise/Sunset Calculations

```
118.30 124.30
Sunrise/sunset
wpt:KROG 25-nov-96
Rise 13:03 Set 23:03
```

Sunrise/sunset planning page showing UTC (Zulu) sunrise and sunset times for 'KROG'.

The GNC 300XI's **sunrise/sunset planning function** allows you to calculate the time of sunrise or sunset at any waypoint or your present position for a specified date.

To calculate sunrise and sunset times at a waypoint or at your present location:

1. Press **NAV** and rotate  until NAV Menu 2 is displayed.
2. Press **CRSR** twice and rotate  to highlight 'Sunrise?'. Press **ENT**.
3. Use  and  to enter the waypoint identifier, or leave blank to use current position. Press **ENT**.
4. Press **ENT** to accept the waypoint information.
5. Use  and  to enter the date desired.
6. Press **ENT** and the sunrise and sunset times will be calculated and displayed. The times will be displayed in your local time or UTC time, whichever is specified from the clock function on NAV Menu 2.

Section 2

Communicating with the GNC 300XL

COMM FEATURES

Overview

SECTION
2

The GNC 300XL features a digital VHF radio that provides a seamless transition from communication to navigation, bringing the two most important functions in flying together in one panel-mount unit. The GNC 300XL operates in the aviation voice band, from 118.000 to 136.975 MHz, in 25 kHz steps.

Communication frequencies are selected by activating the cursor in the **standby frequency field** and using the inner and outer knobs to dial in the desired frequency. A frequency may also be quickly selected from the navigation database by simply highlighting the frequency and pressing the **ENT** key. Once a desired frequency is displayed in the standby field, it may be made the active frequency by pressing the **◀ ▶** key. *Note that the active frequency may not be accessed directly.* Whenever the cursor is active in the comm window, the standby frequency will be highlighted.

To access the standby frequency, press **CRSR.**

This allows you to change the megahertz (number to the left of the decimal) by rotating **○** and the kilohertz (number to the right of the decimal) by rotating **●**. If you would like to keep the standby field 'hot' (ready for an immediate frequency change), leave the cursor active in the comm window. To remove the cursor, press **CRSR** twice after you have selected the desired frequency.

To make the standby frequency the active frequency, press **◀ ▶.**

The frequencies will be flip-flopped and you'll be able to transmit and receive on the frequency previously entered as standby. This can be done at any time, regardless of cursor or GPS status.



118.30 124.30
++++↑++++ gs :120^K
dis 30.78^M trk 260°
go to:KFOE ete15:24

CDI page with cursor inactive.



118.30 **124.30**
++++↑++++ gs :120^K
dis 30.45^M trk 260°
go to:KFOE ete15:14

*CDI page with standby field active. To flip-flop the frequencies, press **◀ ▶**.*

SECTION 2 COMM FEATURES

2

Overview Auto-Tuning

```
118.30 118.70
nr1 apt KTOP 880f
300° 10.6M twr 118.70
rnwy 13 /31 5000f
```

To auto-tune from the nearest airport page, press **ENT**.

```
118.30 122.95
KTOP      clr 121.90
gnd 121.90 twr 118.70
uni 122.95
```

To select a frequency from a list, highlight the desired frequency and press **ENT**.

During the course of navigating with the GNC 300XL, there may be times when you need to quickly select a comm frequency while you are entering data in the GPS window. Whenever data entry in the GPS window is interrupted by activating the standby frequency field, the GPS field in use will become 'splatted', or blocked out.

```
118.30 122.95
Enter wpt gs : 0k
dis -----n trk 356°
go to:KTCM_ ete_:_
```

```
118.30 122.95
Enter wpt gs : 0k
dis -----n trk 356°
go to: [splatted] ete_:_
```

Once the standby frequency has been entered, you may return to data entry by pressing the **CRSR** key. The cursor will return to the active GPS field at the point where data entry was interrupted.

The GNC 300XL's **auto-tune feature** allows you to quickly select any database frequency in the GPS window as your standby frequency.

To auto-tune a single frequency displayed in the GPS window:

1. Press **ENT** with the cursor inactive.
2. To make the standby frequency the active frequency, press **◀▶**.

To auto-tune a frequency from a list displayed in the GPS window:

1. Press **CRSR** twice to activate the cursor in the GPS window.
2. Rotate **○** to highlight the desired frequency.
3. Press **ENT** to make the selected frequency the standby frequency.

Another useful feature integrating the GNC 300XL's navigation and communication capabilities is the **Navigation Communications (NAVCOM)** page, which is accessed using the **NAV** key. See pages 17-18 for more on the NAVCOM page.

The GNC 300XL's **automatic squelch** and **volume controls** are located at the bottom left of the unit, near the NavData card slot.

To adjust the radio volume:

1. Rotate the  knob.

Whenever the GNC 300XL is powered up, the automatic squelch will be in the 'on' position, allowing only transmissions which are powerful enough for clear broadcast to be received. Manual squelch control is not available.

To override the automatic squelch control:

1. Press the  key. Press  again to return to automatic squelch.

Whenever the GNC 300XL is transmitting, a 'tx' icon will appear between the active and standby frequency fields. If the microphone is stuck or accidentally left in the keyed position, or if the headsets continue to transmit after the key is released, the radio will automatically timeout after 35 seconds of continuous broadcasting. You'll also receive a 'Stuck mic/Tx disabled' message as long as the stuck condition exists.

The GNC 300XL's **emergency channel select feature** provides a quick method of selecting the 121.5 MHz frequency as the active frequency in the event of an in-flight emergency. The emergency channel select is available whenever the unit is on, regardless of GPS or cursor status, or loss of the display.

To automatically tune for emergency transmission:

1. Press and hold the  key for more than two seconds.

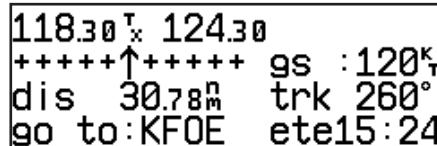
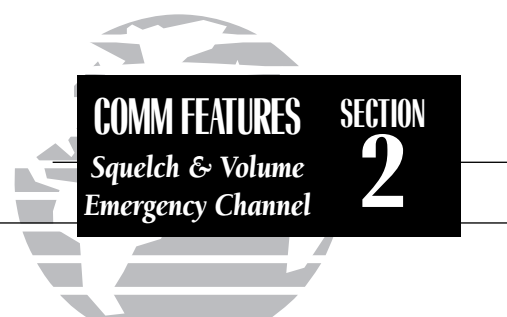

'TX' indicating radio transmission.

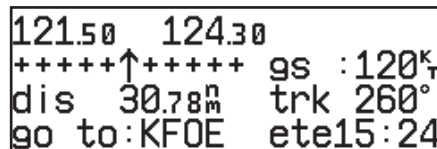

The emergency channel (121.50) will appear in the active field by pressing  for more than two seconds.

SECTION 3

WPT KEY Overview

Please note that your GNC 300XL uses ICAO identifiers for all airports. All U.S. airport identifiers which contain only letters use the prefix 'K'. For example, Los Angeles International is KLAX under the ICAO standard. Other airports, such as Otten Memorial (3VS), that contain numbers in the identifier, do not require the 'K' prefix. Many foreign countries use two letter prefixes. For more information on ICAO identifiers, contact:

Document Sales Unit
International Civil Aviation Organization
999 University Street
Montreal, Quebec
Canada H3C 5H7

Section 3 Waypoint and Database Information

The GNC 300XL uses a Jeppesen NavData® card to provide position and facility information for thousands of airports, VORs, NDBs and intersections. Each facility in the database is stored as a waypoint with its own latitude/longitude, identifier (up to five letters and/or numbers), and other pertinent information. Up to 1,000 user waypoints may also be created and stored in the GNC 300XL's internal memory.

Waypoint Menu Page

```
118.30 124.30
Select waypoint type
apt? vor? ndb?
int? user?
```

Proximity Waypoints Page

```
118.30 124.30
Proximity waypoints
:KACY dis:15.00
:_____ dis:_____
```

```
118.30 125.30
Wpts with comments
KIXD KLAX KSUSM
OTTER RUCKR
```



```
118.30 124.30
3 user waypoints
KSUSM in rt 1 (prx)
RUSHM
```

Waypoints with Comments List

User Waypoint List

Waypoint information is available through four primary waypoint pages accessible from the GNC 300XL's **WPT** key. The waypoint pages may be scrolled through by pressing the **WPT** key and rotating the outer knob until the desired page is displayed, or by pressing the **WPT** key repeatedly.

The GNC 300XL organizes waypoints into one of five waypoint categories for your convenience. Each waypoint category provides different types of detailed information for a selected facility:

- **Airports** - Identifier, city/state, country, facility name, position (lat/lon), elevation, fuel services, control and approach information, IFR procedures, runways and communication frequencies.
- **VORs** - Identifier, city/state, country, facility name, position (lat/lon), frequency, magnetic variation, co-located DME or TACAN and weather broadcast indication.
- **NDBs** - Identifier, city/state, country, facility name, position (lat/lon), frequency and weather broadcast indication.
- **Intersections** - Identifier, country, position (lat/lon) and nearest VOR.
- **User** - Identifier (name), position (lat/lon) and reference waypoint.

To view the waypoint information for a desired waypoint, select the appropriate waypoint category from the waypoint menu page.

To choose a waypoint category (for viewing information):

1. Press **WPT** and rotate **○** to display the waypoint menu page. (If pressing **WPT** once does not display the waypoint menu page, press **WPT** a second time.)
2. Press **CRSR** twice and rotate **○** to highlight the desired waypoint category.
3. Press **ENT** to accept the waypoint category. The waypoint identification or position page for the selected category will appear with the waypoint identifier field ready for entry.

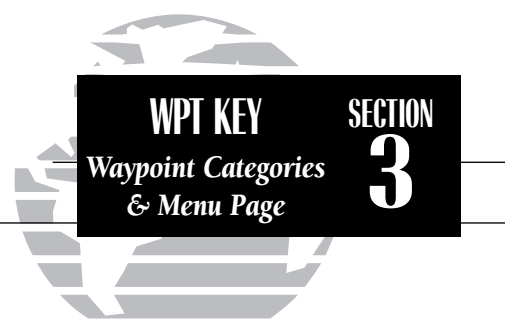

```
118.30 124.30
Select waypoint type
apt? vor? ndb?
int? user?
```

The waypoint menu page allows you to select the desired waypoint type (or category).

```
125.15 121.90
KICT 1330' av/jet
N37° 39.00' W097° 25.99'
ils class C
```

The airport position page shows the position, field elevation and available fuels for the selected airport.

SECTION

3

WPT KEY

Entering Waypoints

```

123.00 122.80
apt:KUK N CEN USA
BURLINGTON KS
COFFEY CO
  
```

Entering a waypoint by identifier.

```

119.92 121.90
apt:KSTL N CEN USA
ST LOUIS MO
LAMBERT ST LOUIS INT
  
```

Entering a waypoint by city. Note that punctuation marks are not used when entering locations or names. Use spaces, where appropriate, to identify these marks. For example, St. Louis would be entered as "ST LOUIS" without a period.











After a waypoint category is selected, information for a waypoint may be viewed by entering the identifier or name of the desired waypoint. Airports, VORs and NDBs may be entered by either the identifier, name or the location (city) of the facility. Intersections and user waypoints must be entered by the identifier.



To enter a waypoint identifier:

1. With the cursor over the waypoint field, use  and  to enter the waypoint identifier.

As the identifier is entered, the GNC 300XL's SpellN'Find™ feature will scroll through the available database, displaying those waypoints matching the identifier letters you have entered to that point. When the desired waypoint is displayed, press  to remove the cursor.

To obtain waypoint information by entering the facility name of the airport or navaid, or its location:

1. Press  and rotate  to display the waypoint menu page.
2. Press  twice and rotate  to highlight the desired waypoint category.
3. Press  to accept the waypoint category.
4. Rotate  to highlight the middle field to enter location (city) **OR**:
Rotate  to highlight the bottom field to enter facility name or VOR/NDB name.
5. Use  and  to enter the location or the name, and press  to finish.

As the information is entered, the GNC 300XL will display any entries in its database that match the letters you have entered. If duplicate entries exist for the entered identifier, name or location, additional entries may be viewed by rotating . Once the desired waypoint is displayed, press  to continue.

Once a waypoint category and identifier have been selected, the GNC 300XL will provide extensive information through a set of waypoint pages for the selected category. The pages available for each waypoint category are presented here in the order they appear on the waypoint menu page: airports, VORs, NDBs, intersections and user waypoints.

Airport Information

Airport Identification Page

```
125.15 121.90
apt:KICT N CEN USA
WICHITA KS
WICHITA MID CONTINEN
```

Airport Comments Page

```
125.15 121.90
apt:KICT comments
INTENSIVE FLIGHT
TRAINING
```

```
125.15 121.90
KICT↓ 01L/19R 10300',
hard srfc ft lights
ils ITWI 10910 rw01L
```

Airport Runway Page

```
125.15 121.90
KICT↓ ats 125.15
clr 125.70 gnd 121.90
twr 118.20 uni 122.95
```

Airport Communication Page

Airport Position Page

```
125.15 121.90
KICT 1330' av/jet
N37° 39.00' W097° 25.99'
ils class C
```

```
125.15 121.90
KICT approach
ndb rw01R
↑ rnav rw01L
```

Airport Procedures Page

```
122.80 123.60
apt:KTCS SW USA
TRUTH OR CONSEQUEN NM
OR CONSEQUENCES MUN
```

If the city or facility name information is too long to fit the screen, the name will scroll across the page every few seconds so the complete name can be read.

```
125.15 121.90
KICT 1330' av/jet
N37° 39.00' W097° 25.99'
ils class C
```

The airport position page shows the position, field elevation and available fuel types for the selected airport.

To scroll through the airport pages:

1. Make sure the cursor is not present. If it is, press **CRSR**.
2. Rotate  in either direction to scroll through the available pages.



SECTION

3

WPT KEY

Airport Pages

```
125.15 121.90
KICT↓   ats 125.15
clr 125.70 gnd 121.90
twr 118.20 uni 122.95
```

Airport communication page. The down arrow next to the identifier indicates additional frequencies may be displayed by rotating the  knob.

```
125.15 121.90
KICT↓ 01L/19R 10300f
hard srffc ft lights
ils ITWI 109.10 rW01L
```

Airport runway page. The down arrow next to the identifier indicates additional runways may be displayed by rotating the  knob.

The GNC 300XL features six airport pages:

airport identification— allows entry of desired airport by identifier, facility name or city; displays region and/or country of facility.

airport position— allows entry of desired airport by identifier; displays latitude, longitude and elevation; indicates usage and fuel availability; displays available approaches and airport control/radar capability.

airport procedures— allows entry of desired airport by identifier; displays all available approaches, SIDs and STARs for the selected airport.

airport communication— allows entry of desired airport by identifier; displays radio frequencies/usage, and sector and altitude restrictions.

airport runway— allows entry of desired airport by identifier; indicates runway designations, length, surface and lighting information; displays ILS/localizer and/or pilot-controlled lighting frequencies.

airport comments— allows entry of desired airport by identifier; displays user comments for the selected airport.

*Waypoint Type
and Identifier*

Region/Country

*Location
(city/state)*

```
125.15 121.90
apt:KICT N CEN USA
WICHITA KS
WICHITA MID CONTINEN
```

Facility Name

The **airport identification page** displays a selected airport's identifier, region and country, city/state and facility name. The identification page is always the first airport page available, allowing you to quickly review an airport facility or select another facility by entering the identifier, facility name or city of the desired airport.

The **airport position page** displays the latitude, longitude and elevation of the selected airport, as well as usage or fuel availability, available approaches and airport control/radar capability. The following descriptions and abbreviations are used on the airport position page:

Elevation— In feet or meters

Usage/Fuel— If the airport is for military use, it will display ‘military’.

If it is private, the GNC 300XL will display ‘private’. If it is a public airport, it will display the fuel type(s) available:

- **av gas**— 80-87 octane, 100 LL, 100-130 octane, or mogas is available
- **jet**— Jet A, Jet A-1 or Jet A+ fuel is available
- **av/jet**— Both av gas and jet fuel are available

Position— In degrees/minutes or degrees/minutes/seconds of latitude and longitude.

Approach Information— displays the airport approaches available

- **no apr**— No approach is available
- **np-apr**— Non-precision approach is available
- **loc**— Localizer approach is available
- **ils**— ILS approach is available

Controlled Airspace Information— displays controlled airspace type

- **class B**
- **class C**
- **cta**
- **tma**

Radar— displays approach/departure radar capability

- **radar**— indicates radar is present

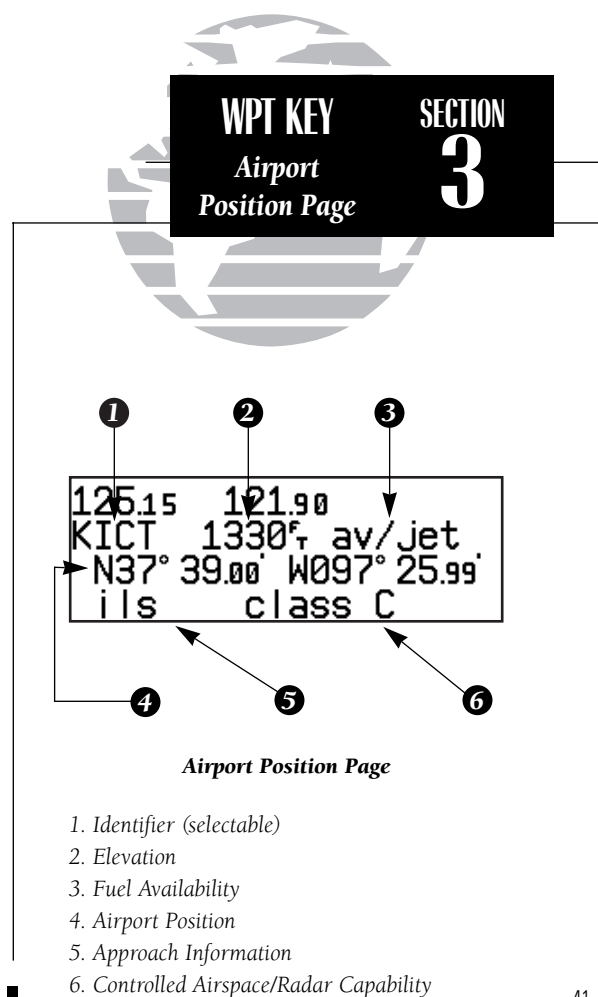

SECTION

3

WPT KEY

Airport Procedures
Page

```

121.15  121.80
KCLT sid
  HOR8
↓ HUG4

```

SID Procedures Page

```

121.15  121.80
KCLT star
  CTF8
↓ MAJIC9

```

STAR Procedures Page

The **airport procedures page** displays all the available approaches, SIDs and STARs at any selected airport in the database, without placing a specific approach, SID or STAR in the active route. This allows the pilot to quickly scan the procedures of any nearby airport in case of an emergency or help plan future flights. You may view the available non-precision approaches, SIDs or STARs by selecting the desired list from the procedure type field.

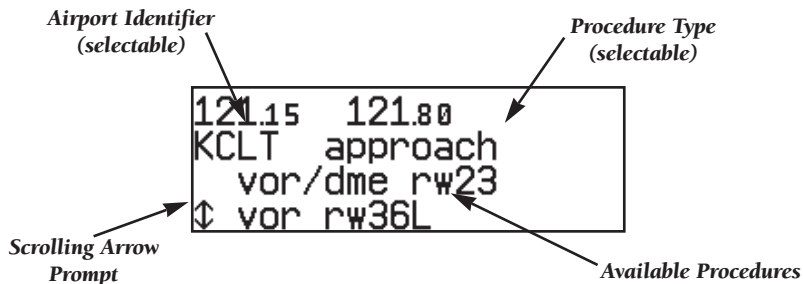

**To view the available procedures for a selected airport:**

1. Press **WPT** and rotate **○** to display the airport procedures page.
2. Press **CRSR** twice and rotate **○** to highlight the procedure field.
3. Rotate **●** to select the approach, SID or STAR list.
4. Press **CRSR** to remove the cursor.

Whenever there are more than two available procedures for a selected category, the GNC 300XL will display a scrolling arrow prompt on the left side of the list. To view additional procedures, simply rotate **●** with the cursor removed. As you scroll through the list, the arrow prompt will point “down” to indicate additional listings below the displayed procedures, “up” to indicate additional listings above, or a “double arrow” to indicate the list may be scrolled up or down.

The **airport communication page** displays the radio frequencies and usage for the selected airport, as well as sector and altitude restrictions.

To view the communication page from any of the airport information pages:

1. Rotate  with the cursor removed to display the communication page.
2. Rotate  in the direction of the arrow prompt to view additional frequencies. You may also view additional frequencies with the cursor on the page by rotating the  knob.

The following descriptions and abbreviations are used on the communication page:

Frequencies without restriction information:

- **ats** - Automatic terminal information service (ATIS)
- **ptx** - Pre-taxi
- **clr** - Clearance delivery
- **gnd** - Ground
- **twr** - Tower
- **uni** - Unicom
- **mul** - Multicom
- **atf** - Aerodrome traffic frequency
- **ctf** - Common traffic advisory frequency (CTAF)
- **mf** - Mandatory frequency
- **oth** - Other frequencies

Frequencies with restriction information:

- **dep** - Departure
- **arv** - Arrival
- **cta** - ICAO control area
- **class C**
- **apr** - Approach
- **class B**
- **tma** - ICAO terminal control area
- **trsa** - Terminal radar service area

'Receive only' frequencies will be followed by an 'rx' indicator, while 'transmit only' frequencies will display a 'tx'. If a frequency has sector and/or altitude restrictions, they will also be displayed. Sector restrictions define a range of radials from the facility, while altitude restrictions may describe an area above, below or between altitudes. Additional instructions, if available, will be displayed on the bottom line.



```
121.15 121.80  
KCLT↓ atsrx121.15  
atsrx132.10 clr 127.15  
gnd 121.80 gnd 121.90
```

Airport communications page for KCLT. Note the 'rx' (receive only) indication on the ATIS frequencies.

```
133.80 121.65  
KLAX↑ dep 124.30  
045-224°
```

Frequency page with sector restrictions.

SECTION

3

WPT KEY

Airport
Runway Page

```
125.15 121.90
KICT↓ 01L/19R 10300ft
hard srfc ft lights
ils ITWI 109.10 rw01L
```

Airport runway page for KICT.

```
125.15 121.90
KICT↓ 01R/19L 7300ft
hard srfc ft lights
ils IICT 110.30 rw01R
```

To view additional runways, rotate the ● knob in the direction of the arrow prompts.

The **airport runway page** displays runway designations, length, surface and lighting for the selected airport, as well as ILS/localizer and/or pilot-controlled lighting frequencies.

To view the runway page from any of the airport information pages:

1. Rotate ○ with the cursor removed to display the runway page.
2. To view additional runway information, rotate ● with the cursor removed.
The scrolling arrow prompt, located beside the identifier field, indicates which direction to scroll for additional runway information.

If a localizer and/or ILS are used on the same runway, rotating ● will sequence through both sets of information.

The following descriptions and abbreviations are used on the airport runway page:

Runway surfaces:

- **hard** - Hard (concrete, asphalt, etc.)
- **seal** - Sealed surface
- **dirt** - Dirt surface
- **unkn** - Unknown surface
- **turf** - Turf (grass)
- **grav** - Gravel surface
- **soft** - Unknown soft surface
- **watr** - Water landing site

Runway lighting:

- **pt lights** - Part-time lights
- **ft lights** - Full-time lights
- **pc** - Pilot-controlled (with frequency) lights
- **no lights** - No runway lighting

VOR Information

The GNC 300XL features three VOR waypoint pages:

VOR identification— allows entry of desired VOR by identifier, facility name or city; displays region and/or country of facility.

VOR position— allows entry of desired VOR by identifier; displays latitude, longitude and frequency; provides magnetic variation, weather broadcasts and DME/TACAN information.

VOR comments— allows entry of desired VOR by identifier; displays user comments for the selected facility.

VOR information is accessed by entering the desired facility by identifier, city or facility name (see page 38) on a VOR waypoint page. The VOR identification and comments pages are identical in form and function to their airport page counterparts.

To scroll through the VOR pages:

1. Make sure the cursor is not present. If it is, press **CRSR**.
2. Rotate **○** in either direction to scroll through the available pages.

In addition to displaying the VOR frequency, magnetic variation and position, the VOR position page indicates if a DME or TACAN is co-located at the facility. The 'wx bdcst' field indicates that the VOR also transmits weather information.

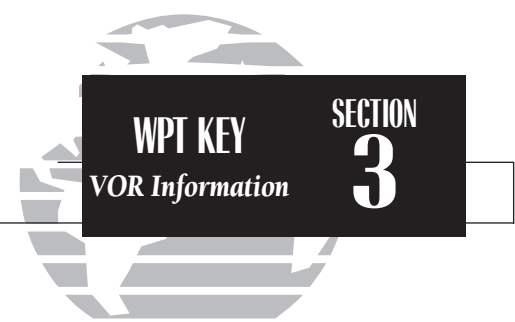

```
125.15 121.90  
vor : POM SW USA  
POMONA CA  
POMONA
```

VOR identification page

```
125.15 121.90  
vor : POM 110.40 E015°  
N34° 04.70' W117° 47.22'  
tacan wx bdcst
```

VOR position page showing co-located TACAN facility and weather broadcast.

SECTION

3

WPT KEY

NDB Information

```
125.15 121.90
ndb:AM      SE USA
TAMPA
PICNY      FL
```

NDB identification page

```
125.15 121.90
ndb:AM      comments
WX BROADCAST INOP
```

*NDB comments page***NDB Information**

```
125.15 121.90
ndb:AM      388.0
N27° 51.68' W082° 32.76'
WX bdcst
```

NDB Position Page

The GNC 300XL also uses identification, position and comments pages for NDB information. The NDB waypoint pages are used in the same manner as VOR pages: NDB information is accessed by entering the desired facility's identifier, city or name (see page 38) on the NDB identification page.

To scroll through the NDB pages:

1. Make sure the cursor is not present. If it is, press **CRSR**.
2. Rotate **⊖** in either direction to scroll through the available pages.

The NDB position page (see above) displays the selected facility's identifier, frequency and position, as well as any weather broadcasts available. The NDB comment page will display any user comments for the selected NDB (see page 54 for instructions on entering user comments).

Intersection Information

```
125.15 121.90  
int:OTTER N CEN USA  
N38° 51.50' W095° 32.01'  
r TOP 173° 16.7M
```

Intersection Position Page

The last database waypoint category available is intersections. Two intersection pages are available: intersection position and intersection comments. Intersections may be entered by identifier only (not city or name) on either intersection page.

To scroll through the intersection pages:

1. Make sure the cursor is not present. If it is, press **CRSR**.
2. Rotate **○** to toggle between the available pages.

The intersection position page displays the selected facility's identifier, region and/or country, latitude and longitude, and the identifier, distance and bearing to the nearest VOR (not necessarily the VOR used to define the intersection). The intersection comment page will display any user comments for the selected intersection (see page 54).

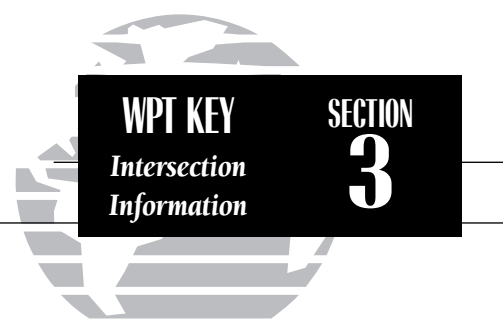

```
125.15 121.90  
int:OTTER comments  
WATCH FOR CARGO ACFT  
ON TRNG MANUEVR KFOE
```

Intersection comments page

SECTION

3

WPT KEY

User Waypoints

```
118.70 122.80
usr:KSUSM
N39° 12.37' W096° 35.40'
fr:KTOP 275.9° 45.9m
```

User waypoint page



```
118.70 122.80
usr:KSUSM comments
KSU FOOTBALL STADIUM
```

User waypoint comments page

User Waypoint Information







In addition to the airport, VOR, NDB and intersection waypoints contained in your NavData® card, the GNC 300XL allows you to store up to 1,000 user-defined waypoints. Once a user waypoint is created, two user waypoint pages will display the following information:

- Waypoint identifier
- Position in latitude and longitude
- Identifier, range and bearing from a reference waypoint
- User comments

To scroll between the user waypoint position page and the user comments page, rotate . User waypoints may be created or modified using the  key. After selecting the waypoint identifier, as shown on page 38, you will be prompted to enter information if the waypoint is new. There are three ways to create a user waypoint's position from the  key:

1. Enter the exact position of the new waypoint.
2. Reference a known waypoint by range and bearing.
3. Enter a range and bearing from your current position.

To create or edit a user waypoint:







1. Press .
2. Press  twice and use  to highlight the 'user?' field. Press .
3. Use  and  to enter the waypoint identifier. Press .

If the waypoint identifier entered does not exist, you will be prompted to select a method to enter the new waypoint's position into memory. If the waypoint exists (i.e., you're just reviewing or editing a user waypoint), skip step 4 and move on to the next set of instructions.



4. Select the desired waypoint entry method using  and press .

You will automatically be placed on the latitude and longitude field (if you selected 'enter posn?'), the 'from' field (if you select 'ref wpt?') or the 'bearing' field (if you select 'rng/brg from posn?').

To enter/edit the position of the user waypoint:

1. Use  and  to enter the latitude. You may select either north or south and enter a latitude up to (but not including) 90°.
2. Press .
3. Use  and  to enter the longitude. You may select either east or west and enter a longitude up to (but not including) 180°.
4. Press .

Once the latitude and longitude have been entered, the cursor will move to the reference waypoint field, where you may enter a reference waypoint to calculate a bearing and distance to the new waypoint position. If you are not entering a reference waypoint:

5. Press  to advance the cursor to the 'ok?' prompt and press  to save the new waypoint in internal memory.

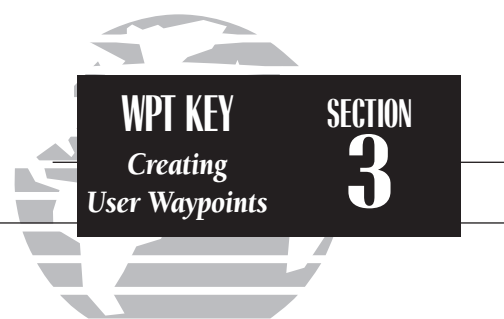

```
118.30 124.30
usr RUSHM is new
enter posn? ref wpt?
rng/brg from posn?
```

Selecting a method to enter a new user waypoint.

```
118.30 124.30
usr:RUSHM
N43° 52.92' W103° 27.00'
r:----- ----.----.ok?
```

Entering the user waypoint's exact position.

SECTION

3

WPT KEY

Reference Waypoints

```
118.70 122.80
usr: GARMN
N38° 53.78' W094° 48.12'
fr: KOJC 310.0° 4.2M OK?
```

Entering a user waypoint by referencing another waypoint.

```
118.20 126.70
usr: WAIME
N21° 38.26' W158° 03.42'
fr: _____ 328.0° 20.5M OK?
```

To create a user waypoint from your present position, leave the reference waypoint field blank and enter a bearing and distance from your present position. The GNC 300XL will calculate the new waypoint's coordinates automatically.

To enter/edit a user waypoint position from a reference waypoint:

1. Use and to enter the reference waypoint's identifier.
2. Press **ENT**. The waypoint's position will appear.
3. Use and to enter the bearing from the reference waypoint.
4. Press **ENT**.
5. Use and to enter the distance from the reference waypoint.
6. Press **ENT**. The latitude and longitude will be calculated for the waypoint.
7. Press **ENT** to confirm the 'ok?' prompt and save the waypoint position.

If you have chosen to create a waypoint at a certain bearing and distance from your current position, your current position will be displayed and you will enter the bearing and distance at which you would like the new waypoint to be located.

To create a user waypoint offset from your present position:

1. Use and to enter the bearing from your position.
2. Press **ENT**.
3. Use and to enter the distance from your position.
4. Press **ENT**. The latitude and longitude will be calculated for the new waypoint.
5. Press **ENT** to confirm the 'ok?' prompt and save the waypoint position.



The GNC 300XL's **AutoStore™ function** provides another method of creating user waypoints. AutoStore is used to instantly capture your present position as a user waypoint with a touch of a button and add the new waypoint to the end of a specified route, if desired.

To perform an AutoStore:

1. Press **NAV** and rotate  to display the position page or map page.
2. Press **ENT**.

This will display the 'Save waypoint' screen, which will allow you to rename the waypoint and choose the route to which it should be added. The GNC 300XL will assign the next available three-digit number as the default waypoint name, preceded by a '+' sign. This will help you differentiate AutoStore waypoints from other user waypoints.

To change the default name or route of an AutoStore waypoint:

1. Rotate  to select the name or route number field.
2. Use  and  to enter the name or route number. If you do not want to add the waypoint to a route, be sure to keep the route field blank.
3. Press **ENT** to accept.
4. Press **ENT** to confirm the 'ok?' prompt.

If the waypoint name you entered is already assigned to another waypoint, you will be informed with the message 'WPT exists ____'. The default waypoint name will be redisplayed, and you may enter a different name. The new waypoint will only be added to a route if the desired route number is manually entered in the route field.

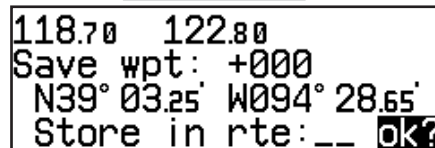

AutoStore waypoint with default name.

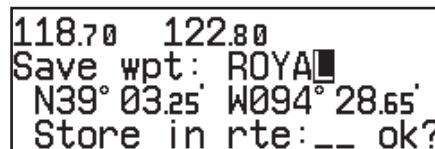

The default waypoint name may be changed before saving the waypoint.

SECTION

3

WPT KEY

Proximity Waypoints

```

122.80 118.30
Proximity waypoints
:KACY dis:15.0nm
↓ :RUSHM dis: 5.0nm

```

Proximity waypoints page

```

122.80 118.30
Prox alarm-press NAV

```

Proximity alarm message. Pressing **NAV** will display the position page with the bearing and distance from the proximity waypoint indicated on the bottom line.

The second page available from the GNC 300XLs **WPT** key is the **proximity waypoints page**. This page allows you to define an alarm circle around a selected waypoint and is useful in defining alarm circles around towers or obstructions. Up to nine proximity waypoints can be entered, each with an alarm radius of up to 99.9 nm.

To create or edit a proximity waypoint:

1. Press **WPT** and use **○** to display the 'Proximity waypoints' page.
2. Press **CRSR** twice and use **○** to highlight the first available field.
3. Use **●** and **○** to enter the identifier. It may be an airport, VOR, NDB, intersection or user waypoint. Press **ENT**.
4. Use **●** and **○** to enter the radius of the alarm circle. Press **ENT**.

If two proximity waypoints are entered and their regions overlap, you will be informed with the message 'Proximity overlap'. This message will be displayed each time you turn on the GNC 300XL for as long as the overlap remains. **Warning:** If you enter the overlap area you will only be informed of the *nearest* proximity waypoint.

To remove a waypoint from the proximity waypoints page:

1. Press **CRSR** twice, if necessary, to obtain a cursor in the GPS window.
2. Press **CLR** to erase the name, and then **ENT** to delete.

To scroll through the proximity waypoints list:

1. Rotate **●** with the cursor inactive (or use **○** with the cursor active) to scroll through the available proximity waypoints. The scrolling arrow prompt will indicate the direction to scroll to view additional waypoints, if available.

The third page available from the GNC 300XLs **WPT** key is the **user waypoint list**, which can be used to quickly scan, review, rename or delete user waypoints.

To display the user waypoint list:

1. Press **WPT** and use **◂** to display the user waypoint list.
2. To scroll through the list, rotate **⦿**.

The total number of user waypoints is displayed at the top of the page, with the individual user waypoints listed two at a time in alphabetical order below. The **↕** prompt, located at the top left of the page, will indicate which direction to scroll to view additional waypoints. The status of each waypoint will be displayed to the right of the identifier when it is the active-to waypoint, part of an active or stored route or a proximity waypoint. To edit, rename or delete waypoints, the cursor must highlight the desired waypoint.

To highlight a waypoint:

1. Press **CRSR** twice and use **◂** to highlight the desired waypoint.

To edit a highlighted waypoint's position:

1. Press **ENT** to obtain the waypoint position page. Edit the waypoint position as described on page 49. (**Note:** The active-to waypoint cannot be edited.)

To delete a waypoint from the list:

1. Highlight the desired waypoint and press **CLR**. Press **ENT** to confirm the deletion.

To rename a waypoint from the list:

1. Highlight the desired waypoint. Use **⦿** and **◂** to enter a new identifier for the waypoint.
2. Press **ENT** on the confirmation page to change the name, or press **CLR** to cancel.

A screenshot of the user waypoint list. It shows two waypoints: '122.80' and '118.30'. Below them, it says '↕ 5 user waypoints'. The first waypoint is 'ROYAL actv wpt' and the second is 'RUSHM (prx)'.

```
122.80 118.30
↕ 5 user waypoints
ROYAL actv wpt
RUSHM (prx)
```

User waypoint list showing the current active-to waypoint and a proximity waypoint.

A screenshot of the rename waypoint confirmation screen. It shows '122.80 118.30' at the top. Below that, it says 'Rename waypoint'. The 'old name' is 'RUSHM' and the 'new name' is 'RSHMR'. At the bottom right, it says 'ok?' with a cursor pointing to it.

```
122.80 118.30
Rename waypoint
old name RUSHM
new name RSHMR ok?
```

Renaming a user waypoint.

SECTION

3

WPT KEY

Waypoint
Comments

```
122.80 118.30
usr:WAIME comments
WAIMEA-----
```

Entering waypoint comments.

```
118.30 125.30
Wpts with comments
KIXD KLAX KSUSM
OTTER RUCKR
```

Waypoints with comments page

The last page available through the GNC 300XL's **WPT** key is the **waypoints with comments page**, which lists all waypoints that have a user comment. User comments may be added to 250 waypoints stored in the user or NavData® database, and allow you to note two lines of special information concerning a particular waypoint.

To enter user comments:

1. Enter the waypoint identifier from any waypoint page (see page 38), and press **CRSR** to remove the cursor.
2. Rotate **○** to display the 'comments' page.
3. Press **CRSR** twice and use **○** to highlight either the second or third line.
4. Use **●** and **○** to enter the comment.
5. Press **ENT** to accept, and repeat steps 4 and 5, if necessary, to enter information on the other line.
6. Press **CRSR** to remove the cursor.

To view the 'waypoints with comments' list:

1. Press **WPT** and use **○** to display the 'Wpts with comments' page.
2. Use **●** to scroll through the list.

The GNC 300XL will display the waypoints with comments in alphabetical order, up to six waypoints at a time. The scrolling arrow prompt will indicate which direction to scroll to view additional waypoints.

To view comments for a selected waypoint:

1. Highlight the desired waypoint and press **ENT** (or press **CLR** and **ENT** to delete).
2. Rotate **○** to display any other available pages for the selected waypoint.

The GNC 300XL's extensive waypoint database makes it possible for several waypoints to share the same identifier. To ensure that you are selecting the waypoint desired, the GNC 300XL will always offer the **waypoint confirmation page** (which shows the waypoint's position) when an identifier is entered for a particular function.

To accept the waypoint position:

1. Press **ENT** with the cursor over the 'ok?' prompt.

To reject the waypoint position:

1. Press **CLR** with the cursor over the 'ok?' prompt.

Once a waypoint has been accepted or rejected, the previous page will be displayed. If there is more than one waypoint available for a selected identifier, the GNC 300XL will display a duplicate waypoint page for you to choose the desired waypoint. The waypoint identifier and number of duplicates will be shown at the top of the page, with the waypoint type and region of each duplicate indicated below. The waypoints listed are sorted by the distance from your present position.

To scroll through additional duplicate waypoints:

1. Rotate  with the cursor active, or  with the cursor inactive.

To select the desired waypoint from the duplicates list:

1. Activate the cursor and rotate  to highlight the desired waypoint.
2. Press **ENT**. The waypoint confirmation page will appear.
3. Press **ENT** over the 'ok?' prompt to accept the waypoint or **CLR** to reject the waypoint and return to the duplicate waypoints list.



```
122.80 118.30
go to apt:KACY
N39°27.45' W074°34.63'
auto crs 123° ok?
```

Waypoint confirmation page

```
122.80 118.30
9 duplicate MA
ndb S CEN USA?
↓ ndb CANADA?
```

Duplicate waypoints page

SECTION

3

WPT KEY

Locked Waypoints
Waypoint Scanning

```
122.80 118.30
Proximity wpt locked
Route wpt locked
Wpt comment locked
```

Possible messages for locked waypoints.

```
122.80 118.30
Enter wpt gs : 0KT
dis _____n trk 350°
go to: [ ] ete__ : __
```

To blank a waypoint field, highlight the field and press the **CLR** key.

Because the GNC 300XL relies on a NavData card for most waypoint information, there may be instances when waypoint information is not available for use. **Locked waypoints** exist when a waypoint contained in a route, used as a proximity waypoint or with a comment is not contained on the NavData card, or no card is inserted in the unit. If this condition exists, you'll be alerted with a 'Proximity wpt locked', 'Route wpt locked' or 'Wpt comment locked' message when the unit is powered up. The identifier of a locked waypoint will be replaced with a 'lockd' message, which indicates you cannot obtain waypoint information or navigate to the waypoint. The identifier of a locked waypoint may be displayed by highlighting 'lockd' and pressing **ENT**. Locked waypoints may be deleted from routes, the proximity waypoints list or waypoints with comments page by following the instructions in the appropriate section of this manual.

The **waypoint scanning feature** provides a fast way to scan through airports, VORs, NDBs and intersections in the database by identifier, facility name or city. Waypoint scanning may be used from any blank identifier field in the GPS window.

To enter a waypoint by scanning the identifier, facility name or city:

1. With the cursor over a blank identifier field, press **WPT**. If the identifier field is not blank, highlight the field with the cursor and press **CLR** before pressing **WPT**.
2. Use **○** to highlight the waypoint category you wish to scan.
3. Press **ENT** to activate the scanning mode.
4. Rotate **○** to place the cursor over the field you want to scan (identifier, facility or city name).
5. Use **●** and **○** to enter the letters of the identifier, city or facility name. The GNC 300XL will scan the database and display the first waypoint that matches your entry.
6. Press **ENT** to accept the waypoint, and **ENT** again to confirm the waypoint for the function being used.

Section 4 Nearest Waypoints

The GNC 300XL's **NRST** key provides detailed information on the nine nearest airports, VORs, NDBs, intersections and user waypoints within 200 nm of your current position. In addition, it will display the two nearest Flight Service Station (FSS) and center (ARTCC/FIR) points of communication, plus alert you to any Special Use Airspace (SUA) you may be in or near. The **NRST** key can be used in conjunction with the GNC 300XL's direct-to function to quickly set a course to a nearby facility in case of an in-flight emergency.

To view the nearest waypoint information:

1. Press **NRST**.

This will display the nearest airport to your present position, subject to the runway surface type and minimum runway length selected (see page 105).

To scroll through the next eight nearest airports, rotate **⦿**.

You may examine both the communication frequencies and the runway information directly from the nearest airport page. You may also place the displayed frequency into the standby field by pressing **ENT** from the nearest airport page.

To view more comm/runway information:

1. Press **CRSR** twice and rotate **⦿** to highlight the comm field or the runway field.
2. Rotate **⦿** to scroll through more information, if available.

To perform a direct-to on any of the nearest waypoint pages:

1. Press **→**. The waypoint confirmation page will appear.
2. Press **ENT** to accept the waypoint or **CLR** to cancel.

NRST KEY
Overview

SECTION
4

```
122.80 118.30  
nr1 apt KIXD 1090F  
150° 5.93M twr 118.30  
rnwy 17 /35 7300F
```

*Nearest airport with other frequency information. If an airport has multiple frequencies available, they may be quickly viewed without activating the cursor by pressing the **CLR** key repeatedly.*

```
122.80 118.30  
nr1 fss COLUMBIA  
122.15
```

*Nearest FSS page. To view additional frequencies (if available), highlight the frequency and rotate the **⦿** knob.*

SECTION

4

NRST KEY

Special
Use Airspace

```

132.95 125.75
sua1 ahead      8:50
KANSAS CITY    CI B
KMCI 8000fM- ground
  
```

Nearest SUA

```

132.95 125.75
sua1 ahead      7:22
KANSAS CITY APP
KMCI 8000fM- ground
  
```

Nearest SUA with controlling agency displayed.

NOTE: The GNC 300XL will flash the **MSG** key next to the **MSG** key to inform you of SUA alerts. You do not have to repeatedly check the Nearest Waypoint page for SUA information. It is provided to supply more information on the SUA and its boundaries. The GNC 300XL will not flash alerts, however, if it has been turned off or if your altitude is such that you will not enter the buffered airspace. Turning off SUA alerts and setting the altitude buffer is described on page 109.

The nearest waypoints for other categories (VORs, NDBs, etc.) may be viewed by rotating **NRST**. Rotating **NRST** continuously to the left will stop page selection on the nearest airport category.

The next page available under the GNC 300XL's **NRST** key is the **SUA (special-use airspace) alert page**. The SUA alert page will alert you to as many as nine controlled or restricted airspaces near or in your flight path, according to the following conditions:

- If your projected course will take you inside an SUA within the next 10 minutes, the message '**SUA ahead < 10 min**' will be displayed.
- If you are within two nautical miles of an SUA and your current course will take you inside, the message '**SUA Near & Ahead**' will be displayed.
- If you are within two nautical miles of an SUA and your current course will **not** take you inside, the message '**Near SUA < 2nm**' will be displayed.
- If you have entered an SUA, the message '**Inside SUA**' will be displayed.

Note that the GNC 300XL's SUA alerts are based on three-dimensional data (latitude, longitude and altitude) to avoid nuisance alerts. The alert boundaries for controlled airspace are also sectorized to provide complete information on any nearby airspace. Once you have met one of the described conditions, the message annunciator will flash, alerting you of an SUA message.

To view an SUA message:

1. Press the **MSG** key.
2. Press **NRST** again to return to the previous page.

Once you are notified of a SUA alert, detailed information concerning the specific SUA is provided by the **NRST** key.

To view the SUA alert page:

1. Press the **NRST** key.
2. Rotate  one stop to the right to view the SUA alert page.

The SUA alert page contains the following information:

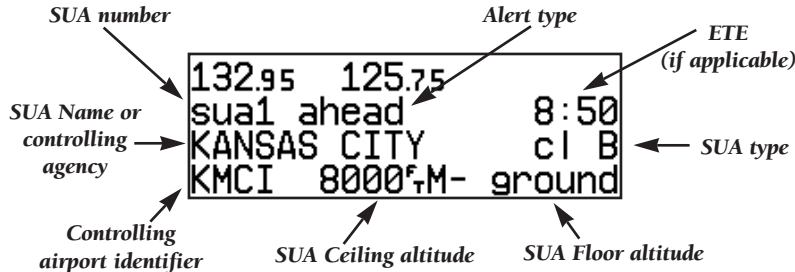

The 'SUA number' field displays which SUA you are viewing (you may be alerted to up to nine SUAs). SUAs are ranked with 'sua1' being the highest priority, and 'sua9' being the lowest priority from your current position. The 'SUA alert' field displays the corresponding alert message for this SUA, such as 'near', 'near & ahead', etc. (see page 58). The ETE (estimated time en route), located at the top right of the page, will only be displayed if you are projected to enter the airspace.

The second line of the SUA alert page displays the name or controlling agency of the SUA, along with the type of SUA to which you are being alerted.

To toggle between the SUA name and controlling agency display:

1. Rotate  one stop in either direction.

If the SUA name or controlling agency is too long to fit on the display, the GNC 300XL will automatically scroll to display the rest of the information.

SECTION

4

NRST KEY

SUA Messages

```

132.95 125.75
sua1 ahead      8:50
KANSAS CITY    cl B
KMCI 8000fM- ground
  
```

SUA alert page

```

132.95 125.75
KMCI↕ class B 118.90
SOUTH OF A LINE FROM
  
```

Frequency information for SUA. If the information is too long to fit on the display, the GNC 300XL will automatically scroll to display the rest of the information.

The following SUA types can appear in the SUA type field:

| Message | Airspace Type |
|---------|-------------------------------|
| alrt | - Alert |
| caut | - Caution |
| cl B | - Class B |
| cl C | - Class C |
| cta | - ICAO Control Area |
| dngr | - Danger |
| moa | - Military Operations Area |
| proh | - Prohibited |
| rstc | - Restricted |
| tma | - ICAO Terminal Control Area |
| trng | - Training |
| trsa | - Terminal Radar Service Area |
| unsp | - Unspecified |
| warn | - Warning |

The last line on the SUA alert page displays the SUA's controlling airport identifier and the ceiling and floor altitudes for the SUA alert. Controlling agency frequencies may be viewed by highlighting the controlling airport identifier with the cursor and pressing **ENT**. The following are examples of what can appear in the altitude fields:

| Message | Meaning |
|---------------------|--|
| 8000 ^f M | - 8000 feet mean sea level (MSL) |
| 3000 ^f A | - 3000 feet above ground level (AGL) |
| ground | - Ground level |
| msl | - Mean sea level |
| notam | - See Notice to Airmen (NOTAM) for altitude restrictions |
| not sp | - Altitude is not specified |
| unlmt | - Altitude is unlimited |

```
132.95 125.75
cl B/cta on moa on
cl C/tma on oth on
alt: 200f rstcd on
```

SUA Settings Page

All SUA alert messages except for prohibited areas may be turned on or off through the GNC 300XL's unit settings options, found under the **MSG** key (see page 108). Alerts for prohibited areas will always be displayed, regardless of unit settings or operating mode. SUA alerts may be turned off so the pilot can avoid continuous alerts in areas with extensive special use airspace. SUA alerts are automatically disabled during approach operations.

Important: Turning off the SUA alerts only stops the display of SUA messages. Any applicable SUA alert pages will still be available from the **NRST** key.

The GNC 300XL also features an altitude buffer which may be set to provide a greater level of protection from penetrating an SUA. By specifying an altitude in the buffer, you can effectively stretch an SUA's altitude boundaries in both directions. This allows the pilot to add an extra margin of prevention around controlled or restricted airspace. For instructions on setting the altitude buffer, see page 109.



```
132.95 125.75
cl B/cta on moa on
cl C/tma on oth on
alt: 500f rstcd on
```

Altitude buffer set at 500 feet. This provides an added 500 foot margin beyond the floor and ceiling limits for an airspace.

SECTION 5

DIRECT-TO & ROUTE NAV

ROUTE TERMINOLOGY

The diagram at the right shows a basic route consisting of five waypoints and four legs.

The waypoint you are travelling to is called the **'active to'** waypoint, and the waypoint immediately behind you is called the **'active from'** waypoint. The course line between the active from and the active to waypoint is called the **'active leg'**.

Section 5 Direct-to & Route Navigation

One of the many benefits of GPS navigation is the ability to fly directly to a waypoint or fly a chain of waypoints without using ground-based navigation aids. To take advantage of the convenience and efficiency provided by point-to-point GPS navigation, the GNC 300XL provides two basic methods of selecting a destination for your flight: **direct-to** and **route navigation**. The direct-to function provides a fast way to set a course to a destination waypoint from your present position. The route function allows the pilot to create a chain of waypoints to fly in sequence and provides access to the GNC 300XL's approach, SID and STAR capabilities.

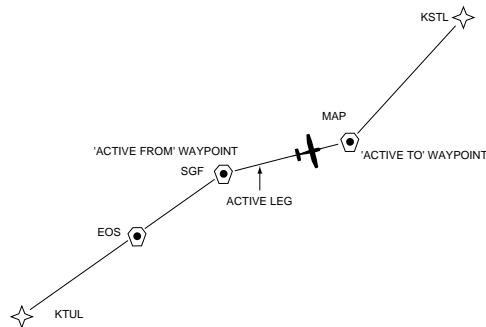

As you pass each waypoint in the route, the GNC 300XL's automatic leg sequencing and turn anticipation features will automatically select the next waypoint as the **'active to'** waypoint and provide smooth steering guidance around the turn. If you are not currently navigating a particular route leg (e.g., your starting position is not a route waypoint), the unit will select the appropriate leg as the active route segment.

The GNC 300XL's **direct-to function** provides a quick method of setting a course to a destination waypoint. Once a direct-to destination is activated, the GNC 300XL will establish a point-to-point route line along the great circle from your present position to the destination and provide steering guidance and navigation data to the waypoint until it is cancelled. If you are navigating to a waypoint and get off course, the direct-to function may also be used to re-center the d-bar to proceed to the same waypoint.

To select a direct-to destination:

1. Press the **→** key. The CDI page will appear with the destination field highlighted.
2. Use **▲** and **▼** to enter the identifier of the desired waypoint.
3. Press **ENT** to confirm the identifier, and **ENT** to accept the direct-to confirmation page.

To re-center the d-bar to the same active-to waypoint:

1. Press the **→** key, followed by **ENT** twice. **NOTE:** If you're navigating an active approach with the MAP as the active waypoint, the approach will be cancelled.

A direct-to may also be quickly activated from many pages that display a single waypoint identifier (e.g., the nearest airport page) by simply pressing **→** and **ENT**. For pages that display a list of waypoints (e.g., the user waypoint list page), you must highlight the desired waypoint with the cursor before pressing the **→** key. Once a direct-to is activated, the GNC 300XL will provide navigation guidance until the direct-to is cancelled or the unit is turned off.

To cancel a direct-to destination:

1. Place the cursor over the destination field on the CDI page.
2. Press **CLR**. The destination field will go blank.
3. Press **ENT**. The GNC 300XL will resume navigating route 0 (the active route) if available.



```
132.95 125.75
Enter wpt gs : 0KT
dis _____n trk 356°
go to:KCOS_ ete__:_
```

To select a direct-to destination, press the **→** key and enter the waypoint identifier using **▲** and **▼**.

```
122.80 118.30
nr1 apt KIXD 1090ft
150° 5.93M twr 118.30
rnwy 17 /35 7300ft
```

To quickly select a direct-to from any page that displays a single waypoint identifier (e.g., the nearest airport page), press **→**, followed by **ENT**.

SECTION 5

DIRECT-TO Manually Selecting A Course

```
118.20 126.70  
go to apt:KICT  
N37° 39.00' W097° 25.99'  
hold crs 200° ok?
```

The waypoint sequencing field, located at the bottom left of the direct-to confirmation page, displays the current status of the external GPS SEQ switch.

To manually set your course from the course select field, set the GPS SEQ switch to the 'AUTO' position and enter the selected course in the course select field. NOTE: Whenever the GPS SEQ switch is set to the 'HOLD' position, the selected course will be determined by the external OBS/HSI.

When using the course select feature on the direct-to confirmation page or when the GPS SEQ switch is set to the 'HOLD' position and external course input is not present, you may also enter the desired course from the CDI page using the course field at the bottom of the page.

Whenever you perform a direct-to, the GNC 300XL will set a point-to-point great circle course to your destination. You can also manually define the course to your destination with the GNC 300XL's **course select** feature. The course select feature is available from the bottom line of the **direct-to confirmation page** and works like selecting an OBS course on a VOR indicator.

**Waypoint Position, Facility
Name or City/Region
(selectable)**

Waypoint Identifier Field

```
118.20 126.70  
go to apt:KICT  
N37° 39.00' W097° 25.99'  
auto crs 229° ok?
```

**Waypoint
Sequencing Field**

Course Select Field

To manually set a course:

1. Set/confirm the GPS SEQ switch in the 'AUTO' position.
2. Press the **→** key. The direct-to confirmation page will appear.
3. Rotate **○** to place the cursor on the course select field.
4. Use **●** to begin entry of the selected course (the **○** and **●** knobs may be used once you have started editing the course select field).
5. Press **ENT** to accept the course, and **ENT** again to acknowledge the 'ok?' prompt.

The GNC 300XL will now use the selected course for your CDI and DTK steering guidance. To reset the course to a GPS-calculated course from your present position, simply press **→**, followed by **ENT**.

ROUTE NAV
Route Pages

SECTION 5

The GNC 300XL lets you create up to 20 routes (numbered 0 through 19), with up to 31 waypoints each. Routes are created, copied and edited through the **RTE** key, which features five route pages selectable from the GNC 300XL's outer knob.

Active Route Page

```
118.20 126.70
KIXD →DODSN cum ete
→DODSN 492.0 0:03
↓ :EMP 653.6 0:44
```

Route Catalog Page

```
118.20 126.70
rte 0 activate?
KIXD /KICT 152.580
Parallel trk: L 0.00
```

Approach Select Page

```
118.20 126.70
Rt 0 KICT slct appr
ndb rw01R?
↓ rnav rw01L?
```

```
118.20 126.70
Rt 0 KIXD slct sid
CHIEF2?
↓ LAKES3?
```

SID Select Page



```
118.20 126.70
Goto KMKC slct star
BRAMB2?
↓ JHAWK2?
```

STAR Select Page

```
118.20 126.70
Copy to route 2
from route 0?
KIXD /KICT
```

REMEMBER!

If you want to save the active route, be sure to copy it to an empty storage route (1-19) before turning the GNC 300XL off or activating a new route (or direct-to destination). See page 69 for instructions on copying routes.

The five route pages can be divided into two types: **active route pages** and a **route catalog page**. Active route pages provide information and editing functions for route 0, which always serves as the route you are currently navigating. The route catalog page serves as the main page for creating, editing, activating, deleting and copying all routes.

Routes 1-19 are used as storage routes, which are stored in the GNC 300XL's internal memory. Once a storage route is 'activated', a copy is placed into route 0 for navigation until it is cancelled, overwritten by activating another route or erased when the unit is turned off. If you want to save a route currently in route 0, be sure to copy it to an open storage route (routes 1-19) before it is cancelled, overwritten or erased.

SECTION 5

ROUTE NAV Route Catalog Page

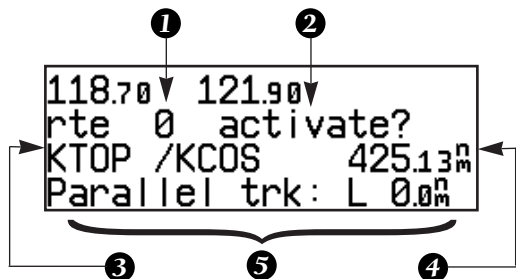

Route Catalog Page

1. Route selection field
2. Route action field
3. Departure/Arrival waypoints
4. Cumulative distance of route
5. Comments/Parallel track offset field

The GNC 300XIs **route catalog page** is used to create, edit, delete or copy routes, and serves as the main page for a host of functions. These include route activation, determining the closest point of approach and search-and-rescue operations. It also displays a summary of routes currently stored in memory, with the departure and arrival route waypoints and total distance for the selected route number. To scroll through the available routes, rotate . A one-line user comment may be added to any storage route, which will be displayed on the route catalog page.

To add user comments to any route (except route 0):

1. Rotate to display the route you would like to add comments to.
2. Press **CRSR** twice and use to highlight the bottom row.
3. Use and to enter comments, and press **ENT**. To erase press **CLR**, then **ENT**.

The **route action field**, located at the top right of the page, is used to select the desired route operation. The following functions are available:

- **Activate** - activate the route for navigation
- **Reverse** - activate a route in reverse order
- **Edit** - create a new route, or edit an existing route
- **Approach** - select an approach for the route (see Section 6)
- **Star** - select a STAR for the route (see Section 6)
- **Sid** - select a SID for the route (see Section 6)
- **Delete** - delete a route
- **Copy** - copy the current route to an empty route
- **CPA** - calculate the closest point of approach
- **Search** - perform search-and-rescue ladder operations
- **RAIM prd** - evaluate enroute RAIM availability over the entire route

The **route editing function** allows you to create new routes and edit existing routes. Creating routes before takeoff can help make route operations faster and easier during your flight.

To create or edit a route from the route catalog page:

1. Use **○** to display the route number you would like to edit.
2. Press **CRSR** twice.
3. Use **○** to select 'edit?'. Press **ENT**. The route review page will appear.

To add a waypoint:

4. Rotate **○** to highlight the first blank waypoint field or the point where you want to enter the new waypoint. The first waypoint field will already be highlighted if you're creating a new route.
5. Use **○** and **○** to enter the waypoint's identifier. Press **ENT**.
6. Press **ENT** to confirm the 'ok?' prompt on the waypoint confirmation page.
7. Repeat steps 4 through 6 to add the next waypoint, or press **CRSR** to finish.

To delete a waypoint:

1. Rotate **○** to highlight the waypoint you wish to delete.
2. Press **CLR** to remove the name, then press **ENT** to delete.
3. Repeat steps 1 and 2 to delete additional waypoints, or press **CRSR** to finish.

To delete an entire route:

1. Use **○** to display the route number you would like to delete (route 0 for the active route).
2. Press **CRSR** twice and use **○** to highlight the action field.
3. Use **○** to select 'delete?'. Press **ENT** to delete.

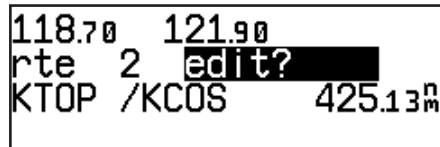

Selecting the route edit function.

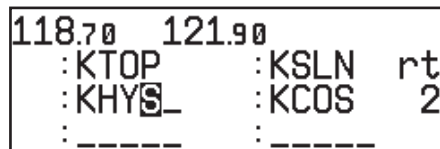

Adding a waypoint to route 2.

SECTION

5

ROUTE NAV

Deleting &
Activating Routes

```

118.70 121.90
rte 0 delete?
KTOP /KCOS 425.13M
Parallel trk: L 0.0M

```

Deleting route 0.

```

118.70 121.90
rte 0 reverse?
KTOP /KCOS 425.13M
Parallel trk: L 0.0M

```

Reversing route 0.

Once a route is defined through the route catalog page, it may be activated from the route catalog page. Activating or reversing a route places the selected route into route 0 and overwrites the existing active route.

To activate a route:

1. Press **RTE** and use to display the route catalog page.
2. Rotate to display the route you would like to activate.
3. Press **CRSR** twice and use to display 'activate?'. Press **ENT**.

After travelling a route or creating a route with the GNC 300XL's AutoStore™ feature, the route activation field may be used to activate the route in reverse order.

To activate a route in reverse order:

1. Press **RTE** and use to display the route catalog page.
2. Use to display the route number you would like to reverse.
3. Press **CRSR** twice and use to display 'reverse?'. Press **ENT**.

This will copy the reversed route to route 0 and display the active route page. The original route will remain intact in its storage route location.

The route action field also features a **copy function** that permits you to copy any route to another open storage route. The copy function can be used to save the contents of the active route (route 0) to an open storage route.

To copy a route:

1. Press **RTE** and use **○** to display the route catalog page.
2. Use **○** to display the route to which you would like to copy to. The route must be empty.
3. Press **CRSR** twice and rotate **○** to select 'copy?'. Press **ENT**.
4. Use **○** to enter the route you would like to copy. The departure/arrival identifiers will be displayed for your reference. Press **ENT** to copy the route.

The **CPA function** calculates the closest distance that a route will pass to a reference waypoint, and helps when creating new route waypoints referenced to a NAVAID.

To calculate the closest point of approach (CPA) from the route catalog page:

1. Use **○** to display the route you would like to use for the CPA function. The route must consist of at least two waypoints, and the reference facility must fall between the waypoints of a route leg.
2. Press **CRSR** twice and rotate **○** to select 'cpa?'. Press **ENT**.
3. Use **○** and **○** to enter the identifier of the reference waypoint.
4. Press **ENT**. The bearing and distance of the closest point on the route will be displayed.
5. Press **ENT** to add the cpa waypoint to the route, or **CLR** to finish. If you do add the cpa waypoint to the route, it will be named based on the reference waypoint plus a number (0-9) added to the end (e.g., KMCI3 for KMCI). If the waypoint does not fall between waypoints on the route, the reference waypoint does not exist or a unique name cannot be assigned to the CPA waypoint, you'll be informed with the 'Invalid CPA wpt ____' message.

ROUTE NAV SECTION

Copying Routes 5

CPA Function

```
120.15 121.75
Closest pt of apprch
route 3 KDAL /KLIT
fr:TXK 327° 26.7m ok?
```

Calculating closest point of approach.

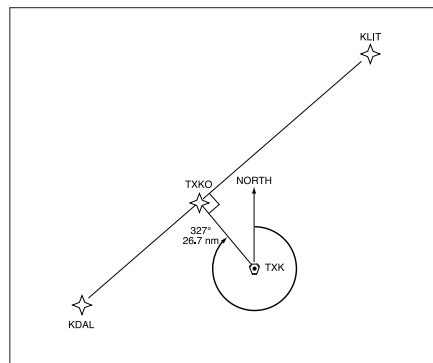

Closest point of approach to 'TXK'.

SECTION 5

ROUTE NAV Search & Rescue Operations

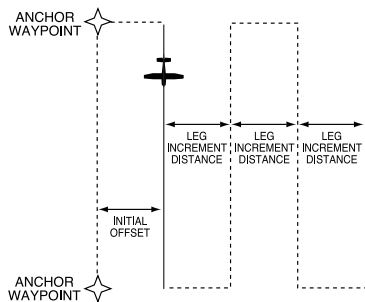

The map page will show the active leg of the search and rescue pattern as a solid line with the anchor waypoints joined together by a dashed line.

```

121.90  118.70
Route 0  KTOP /KFOE
initial offst:L 0.0M
increment:R 0.5M  ok?
    
```

Performing a search-and-rescue operation.

The GNC 300XL's **search-and-rescue function** provides navigation guidance for search-and-rescue operations, navigating in a ladder pattern to maximize coverage and efficiency. This is done in reference to two waypoints called 'anchor waypoints'. The first leg will be a specified distance from the line connecting the anchor waypoints. This is called the 'offset distance'. The 'increment distance' is the distance between each subsequent leg. The ladder can be created on either side of the anchor waypoints.

To perform a search-and-rescue operation:

1. Create a route of **only** two waypoints.
2. Press **RTE** and use **○** to display the route catalog page.
3. Use **●** to select the 2-waypoint route.
4. Press **CRSR** twice and use **●** to display 'search?'. Press **ENT**.
5. Use **●** and **○** to enter the leg increment value and R or L. Press **ENT**.
6. Rotate **○** to highlight the initial offset, and use **●** and **○** to enter the initial offset value, and R or L.
7. Press **ENT** three times to accept the operation values and begin navigation.

After activating a search-and-rescue, you will be informed with an 'Offset nav in effect' message each time you traverse the route offset from the anchor waypoints. The CDI page will guide you along each leg of the ladder pattern. Note that bearing and distance information are referenced to the anchor waypoints. Once you've arrived at the destination waypoint, the leg increment will be added to your present offset, and the route will be automatically reversed. If a search-and-rescue is interrupted, note the parallel track direction (R or L) and distance on the catalog page for route 0. When you resume search-and-rescue operations, use this as the initial offset.

The GNC 300XL's Route RAIM Prediction Function evaluates enroute RAIM availability over the entire route that the pilot intends to fly. Route RAIM Prediction ensures that satellite coverage will be sufficient to meet the protection limits defined by BRNAV/RNP-5 (FAA Advisory Circular 90-96).

To use the Route RAIM Prediction Function:

1. From the Route Catalog Page (Figure 1), select the desired route for RAIM prediction (if the route is empty, enter the route first).
2. Highlight the route action field by pressing **CRSR** twice, rotate **▲** to select 'RAIM prd?' and press **ENT**. The Route RAIM Prediction Page will be displayed (Figure 2).
3. Highlight and enter departure time, departure date, enroute altitude, and enroute ground speed (valid enroute ground speed is "65 nm or greater"). Press **ENT** to accept.
4. When all parameters are properly entered, move the cursor to the 'Compute?' field, and press **ENT**. The unit will start to predict the RAIM availability over the entire route, and will switch to 'WAIT ->', with the arrow sign continually rotating, indicating that the prediction computation is in progress.
5. If RAIM is available for the entire route 'RAIM OK' will appear on the Route RAIM Prediction Page, as shown in Figure 3 (pg. 72).

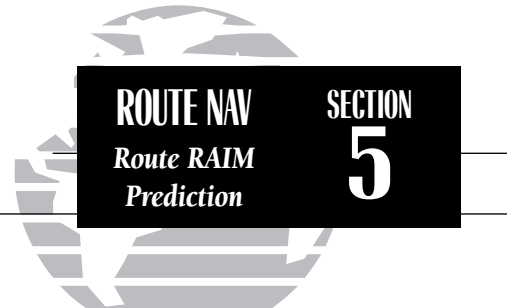

Figure 1

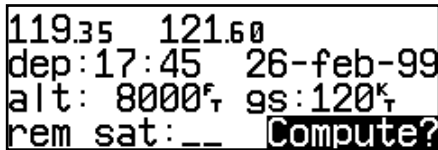

Figure 2

SECTION 5

ROUTE NAV Route RAIM Prediction

```
119.35 121.60  
dep:17:45 26-feb-99  
alt: 8000f gs:120k  
rem sat: __ RAIM OK
```

Figure 3

```
119.35 121.60  
dep:10:00 26-feb-99  
alt: 8000f gs:120k  
rem sat: 9 NO RAIM
```



Figure 4

The time required for RAIM prediction computation depends on the route distance (i.e., 1000 nautical miles = approximately 2 minutes) and the enroute speed. The longer the route distance and the slower the enroute speed, the longer the time. If RAIM unavailability is detected based on the associated requirement, the prediction process will stop immediately and display 'NO RAIM' as shown in Figure 4.

'NO RAIM' does not mean RAIM is unavailable for the entire route. This message results when RAIM unavailability is detected for more than 5 minutes at any point along the intended flight (based on BRNAV requirements).

If a satellite is listed as 'out of service' by NOTAM, you may use the 'rem sat' (remove satellite) field to prevent a particular satellite from being used in the Route RAIM prediction (e.g., removing satellite 9 in Figure 4).

To exclude a satellite from the Route RAIM prediction:

1. Highlight the 'rem sat' field.
2. Rotate  to select the satellite to be excluded.
3. Press  to accept.
4. Press  again to begin Route RAIM Prediction without using the selected satellite.

During route navigation, it is sometimes desirable to navigate a specified distance away from the 'active leg' to help avoid certain airspaces or regions. The GNC 300XL's **parallel track feature** will automatically guide you along a selected offset from the active leg. Bearing and distance information will be to the waypoints along the original course, with the CDI (on the CDI page) centered on the offset course.

To use offset navigation, or 'parallel track':

1. Press **RTE** and use **○** to display the route catalog page.
2. Use **○** to display route 0 (parallel track can only be used on the active route).
3. Press **CRSR** twice and use **○** to highlight the parallel track value field.
4. Use **○** and **○** to enter the desired distance and direction (R or L) from the leg.
5. Press **ENT** to accept. The map page will display the offset route as a solid line and the original route as a dashed line.

It is important to note that offset navigation is only available on route navigation, not direct-to navigation. If an approach is present in the active route, parallel offset navigation is cancelled when entering the 30 nm terminal area. Offset navigation is **NOT** valid for IFR approach procedures. "Approach not active" message will display if parallel navigation is re-instated after approach navigation has been armed. When offset navigation is activated, an 'Offset nav in effect' message will be displayed with the distance and direction noted on the route catalog page for route 0. If you enter an offset which causes a leg to be reversed, you'll be informed with the message 'Ofst too big for rte'. If you change the active route in any way or perform a direct-to, you'll be informed with an 'Offset nav cancelled' message.

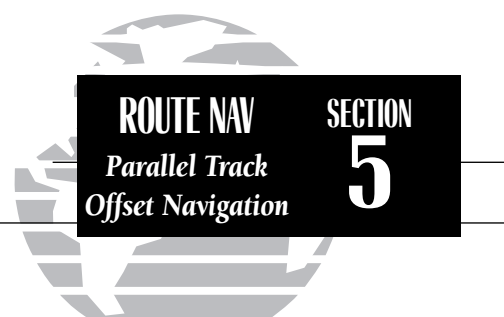

```

121.90  118.70
rte 0  search?
KTOP /KFOE  7.37n
Parallel trk: L 0.5n
  
```

Enter parallel track value after route activation.

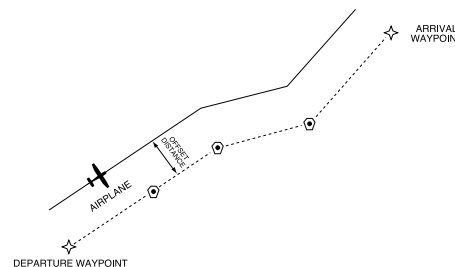

Parallel Track

SECTION

5

ROUTE NAV

Active Route
Page

| | | | |
|--------|--------|--------------------|------|
| 121.90 | 118.70 | | |
| KTOP | →KSLN | cum | ete |
| | →KSLN | 106.7 _M | 0:42 |
| ↕ | :KCOS | 420.7 _M | 2:48 |



USING THE ACTIVE ROUTE PAGE

The GNC 300XL's active route page provides a working list of all waypoints for the route you are navigating, along with distance, timing or desired track information. The scrolling arrow prompt to the left of the route waypoint list indicates which way to scroll to view additional route waypoints.

The active route page can also be used to manually select your next 'active-to' destination (using ) , which allows you to fly directly to any waypoint in the route without modifying the route itself. The GNC 300XL will resume navigation of the remainder of the route in sequence once you arrive at the selected waypoint.

Flying and Modifying the Active Route

Once a route has been created and activated, the GNC 300XL will provide navigation to each route waypoint through the active route, CDI and map pages. From the active route page, you may also create and modify the active route, and insert an approach, SID or STAR. The CDI page will display detailed navigation data on your progress to each route waypoint, and provide turn anticipation, waypoint arrival and next desired track information. By understanding the relationship between the active route and CDI pages and the role of the waypoint sequencing (GPS SEQ) switch, you'll be able to get the most out of the GNC 300XL's advanced route and approach features.

Whenever the GNC 300XL is navigating an approach, route or an on-route direct-to, the **active route page** will provide a list of the route waypoints in sequence, along with distance, time and course information. You may also create and edit a route directly from the active route page. If you want to save a route created from the active route page (route 0), you must copy it to an open storage route (see page 69) before turning the unit off or activating another route. The active route page may be displayed by pressing the  key and rotating  left continuously. It will also appear automatically whenever an approach, route, SID or STAR is activated.



To scroll through the active route waypoints:

1. Rotate  with the cursor inactive (or  with the cursor active).

The active leg identifiers field, located at the top left of the page, displays the waypoint identifiers of the route leg you are currently navigating. The first waypoint identifier displayed is the 'active from' waypoint. The second waypoint is the 'active to' waypoint. The line connecting these waypoints is known as the 'active leg'. If you are navigating a direct-to, the field will display the destination with a 'goto' designation.







The distance field can be selected to display cumulative ('cum') distance or the distance for each route leg ('leg'). If cumulative is selected, the first leg's distance will be displayed. The second leg will represent the first leg's distance plus the second leg, and so on. The time field may be configured to display the estimated time en route (ete), estimated time of arrival (eta) or desired track (dtk) for each leg.

To change the distance and time fields:

1. With the cursor active, rotate  to highlight the field you want to change.
2. Rotate  to select the desired setting and press .

The active route page may also be used to create a new route or edit the route you are currently navigating (approach, SID or STAR waypoints cannot be edited), and provides a fast method of selecting any route waypoint as your next destination waypoint without modifying the active route. If you are editing the active route and want to save it in its original form, copy it to an open storage route before editing.

To add waypoints to the active route:

1. Press  twice, if necessary, to activate the cursor.
2. Use  to highlight the first blank waypoint field, *or* highlight the waypoint before which you would like to add the new waypoint.
3. Use  and  to enter the new waypoint identifier. Press .
4. Press  to accept or  to cancel. The cursor will automatically move to the next waypoint field, and the remaining route waypoints (if any are present) will move down the list accordingly.

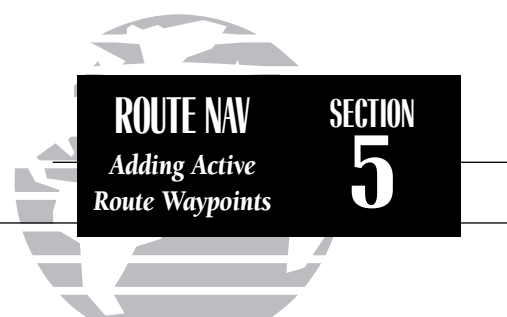

| | | | |
|--------|--------|--------------------|------|
| 121.90 | 118.70 | | |
| KTOP | →KSLN | cum | dtk |
| | →KSLN | 105.3 ⁿ | 264° |
| ↕ | :KCOS | 419.3 ⁿ | 265° |

Active route page with cumulative distance (cum) and desired track (dtk) displayed.

| | | | |
|--------|--------|--------------------|------|
| 121.90 | 118.70 | | |
| KTOP | →KSLN | leg | ete |
| | →KSLN | 104.1 ⁿ | 0:41 |
| ↕ | :KCOS | 314.0 ⁿ | 2:47 |

Active route page with leg distance and estimated time en route displayed.

SECTION

5

ROUTE NAV

On-Route
Direct-To

```

121.90 118.70
go to apt:KSLN
N39° 00.00' W098° 00.00'
hold crs 261° ok?

```

You can hold on a destination waypoint by setting the GPS SEQ switch to the 'HOLD' position. The GNC 300XL will hold on the current 'active to' waypoint as your navigation reference and prevents the unit from sequencing to the next waypoint in the route. A user-defined course may also be selected on the external HSI (OBS).

```

121.90 118.70
+++++↑+++++ gs :150K
dis 101.28M trk 247°
:261° :KSLN ete42:11

```

Whenever waypoint sequencing is set to 'hold', the desired course is displayed at the bottom left of the CDI page. See page 64 for more details.

To delete a waypoint from the active route:

1. Press **CRSR** twice, if necessary, to activate the cursor.
2. Use **○** to highlight the waypoint you would like to delete from the active route.
3. Press **CLR**, followed by **ENT**. The next route waypoint (if available) will move up to take the position of the deleted waypoint.

The active route page also allows you to select your next destination waypoint manually from the active route waypoint list and resume the remainder of the route in sequence. This procedure, referred to as an '**on-route**' **direct-to**, allows the pilot to fly directly to any waypoint in the active route without editing the active route, approach, SID or STAR itself. For example, if you are flying a route with an armed approach, the GNC 300XL will automatically provide the initial approach fix (IAF) for the selected approach as your 'active to' waypoint. If you have been vectored directly to the final approach fix (bypassing the IAF), you can manually "skip ahead" to the final approach fix as your next active to waypoint.

To perform an on-route direct-to from the active route page:

1. Press **CRSR** twice and rotate **○** to highlight the desired waypoint.
2. Press **→**, followed by **ENT** to confirm the 'ok?' prompt on the waypoint confirmation page.

The GNC 300XL will now provide guidance to the selected waypoint and resume navigating the remainder of the route in sequence once you arrive at the next destination waypoint. The **waypoint sequencing field**, located at the bottom left of the direct-to confirmation page, indicates the current status of the waypoint sequencing (GPS SEQ) switch. For more information on the waypoint sequencing switch and waypoint 'hold' operations, see Section 6.

ROUTE NAV SECTION 5

Turn Anticipation

During route operations, the CDI page is used to provide turn anticipation, next desired track and waypoint arrival information to the pilot. The GNC 300XL's **turn anticipation feature** will smooth out the transition between adjacent route legs by providing CDI guidance along a curved path segment. This leg transition is based on the aircraft's actual ground speed and the difference between the course angle of the two legs. The GNC 300XL will automatically sequence to the next leg when you are abeam the 'active to' waypoint on the curved transition segment, and the to/from indicator on the CDI will flip momentarily. During the transition, the CDI display will be referenced to the dotted line illustrated at the right. Turn anticipation will not be provided in the following scenarios:

- Waypoint/fix crossing is a requirement of the approach, SID or STAR you're navigating.
- The GPS SEQ switch is in the HOLD position.
- Your current ground speed and the course angle between the two legs require a bank angle greater than 25° (see right).

As you approach a route waypoint, the GNC 300XL's external waypoint annunciator will flash 15 seconds before the turn anticipation point, and the graphical CDI on the CDI page will be replaced by a flashing 'Next dtk xxx°' prompt (and the desired track readout on the map page will flash), indicating the desired track of the next route leg.

To use the turn anticipation feature, note the 'Nxt dtk' heading when the external waypoint annunciator begins to flash, and start the turn when the annunciator glows steadily (approximately 2 seconds before the turn anticipation point). Once you've reached the turn anticipation point, the desired track (dtk) field on the CDI page will change to display the course for the next leg. If you have not adjusted your HSI course selector before the turn, the 'Next dtk' will continue to flash until you have reached the midpoint of the turn. Please refer to your aircraft flight manual supplement for specific turn anticipation instructions.

Since the **approach select, STAR select and SID select pages** relate to the GNC 300XL's approach features, these pages and their functions are described in Section 6.

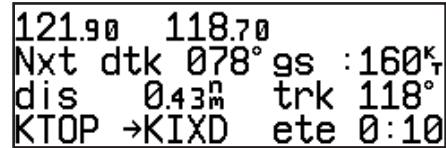

As you approach a route waypoint, the graphical CDI will be replaced by a flashing 'Next dtk xxx°' prompt indicating the desired track of the next leg. When using the map page, the desired track readout will flash and indicate the dtk for the next leg.

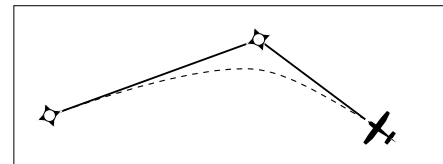

If the turn angle and your present speed will require a bank angle that exceeds 25°, you'll be notified with a 'Steep turn ahead' message approximately 90 seconds before arrival at the active to waypoint.

SECTION

6

APPROACH NAV

Overview

| | | | |
|-----------|--------------------|------|--|
| 118.30 | 124.30 | | |
| go to ANX | cum | ete | |
| ↗→ANX | 40.93 _N | 0:22 | |
| ↓ :SLIMS | 57.34 _N | 0:31 | |

Once an approach is selected, the GNC 300XL will replace the destination airport with the appropriate approach waypoints. The initial approach fix, final approach fix and missed approach point waypoints are indicated by an 'if', 'ff' and 'mp' designation to the immediate left of the waypoints.

In many instances, there may be approach waypoints in the GPS approach that are not shown on the approach plate. These approach waypoints are usually intermediate fixes designed to help the GPS provide smooth navigation along the approach path.

Section 6

Approaches, SIDs and STARs

The GNC 300XL's approach navigation mode allows you to fly non-precision approaches to airports with GPS and overlay procedures using information contained on your Jeppesen NavData® card. GPS approaches are similar to existing IFR approach procedures, but provide additional course and distance information for a higher level of accuracy, efficiency and safety. The non-precision approaches available in the GNC 300XL are executed using the GPS route features covered in Section 5, so it's important to understand routes before attempting approach navigation. A **GPS approach** is a sequence of waypoints linked together as an approach route which replaces your destination airport waypoint when selected. It may be based on an existing RNAV, VOR or NDB approach procedure, or be an entirely new approach created specifically for GPS. Regardless of the type of approach on which a GPS procedure is based, the procedure is flown as a sequence of route legs in the active route.

The GNC 300XL's **auto-arming** feature provides automatic control of the two phases of approach operations: **arm approach** and **active approach**. The arm approach phase consists of selecting an approach from the database and ensuring that the receiver is ready to begin the tighter integrity monitoring and CDI adjustment required for approach navigation. The active approach phase tightens the accuracy requirements and sensitivity one step further to meet TSO standards for the non-precision approach. Auto-arming of the approach will occur once you are within 30 nm of the destination airport, and will be indicated by an 'ARM' message on the external GPS APR switch. The approach will then transition to the active phase when the aircraft is within 2 nm of the FAF along the inbound course to the final approach fix.

The GNC 300XL works in conjunction with a set of external switches and your HSI (OBS) to fly GPS approaches. The external switches are used to control GPS functions, and contain illuminated annunciators to indicate when functions are active. Your installation must also have annunciators for waypoint arrival and GPS messages.

NAV GPS
NAV

NAV GPS
GPS

The **NAV/GPS switch** determines which data (GPS or NAV1) will be displayed on the HSI and used by the autopilot/flight director. The current selection will be indicated by an annunciator light. If power to the GNC 300XL is lost, the system will automatically revert to NAV1.

GPS APR

GPS APR
ARM

GPS APR
ACTV

The **GPS APR switch** is used to arm or deactivate an approach, and indicates the current approach phase status ('ARM' or 'ACTV'). The GNC 300XL will automatically arm a selected approach 30 nm from the airport. If the pilot wishes to terminate the approach or fly the missed approach, the GPS APR switch may be pressed to disarm/deactivate the approach at any time and return the CDI scale sensitivity to the 1.0 nm setting. The GPS APR switch may also be used to re-arm the approach at any time before reaching the FAF. If the selected approach is disarmed before the FAF, the unit will prompt you to re-arm the approach 3 nm before the final approach fix.

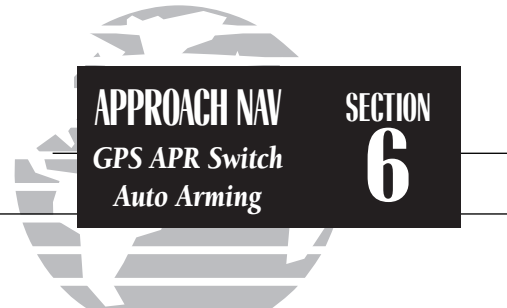

APPROACH NAV
GPS APR Switch
Auto Arming

SECTION 6

118.30 124.30
Arm Approach Mode
Auto CDI slctd

Arm Approach Mode

The external GPS APR switch will automatically be set to the ARM position 30 nm from the destination airport. Once the approach is armed, the unit will provide a smooth transition from the 5.0 to 1.0 nautical mile CDI scale, and down to 0.3 nm within 2 nm inbound to the FAF. If the approach is manually disarmed, it may be re-armed at any time (before reaching the FAF) by pressing the GPS APR switch.

SECTION 6

APPROACH NAV GPS SEQ Switch

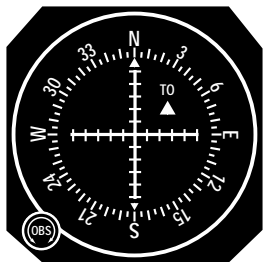

GPS SEQ
AUTO

*Always set the desired course on the HSI (OBS)
BEFORE returning the GPS SEQ switch to the
'AUTO' position.*

GPS SEQ
AUTO

GPS SEQ
HOLD

The **GPS SEQ switch** is used to select manual or automatic waypoint sequencing of waypoints. Setting the GPS SEQ switch to the HOLD position holds your current 'active to' waypoint as your navigation reference and prevents the GPS from sequencing to the next waypoint. When the GPS SEQ switch is set to the AUTO position, automatic waypoint sequencing is selected. Whenever the GPS SEQ switch is engaged, the HOLD annunciator will illuminate and the GPS will continue navigating to the active-to waypoint regardless of your position relative to other waypoints.

The GPS SEQ switch must be set to the HOLD position any time you are deviating from the flight sequence of an approach (e.g., when you are flying radar vectors) or when you must cross the same waypoint twice in succession (e.g., procedure turn, IAF and FAF at the same waypoint). Whenever the GPS SEQ switch is set to the HOLD position, the GNC 300XL allows you to select the desired course to/from a waypoint using the HSI, much like a VOR.

Whenever the GPS SEQ switch is released from the HOLD position, the GNC 300XL will 'capture' the present HSI setting as your desired course. Always dial in your next desired course before returning the GPS SEQ switch to the AUTO position. The GPS SEQ switch may be released from the HOLD position 2 seconds after the inbound course has been set. The GNC 300XL will continue navigation on the last selected course through the active-to waypoint and sequence to the next approach waypoint.

Basic Rules of GPS Approaches

The GNC 300XL is the first GPS/COM certified to meet the requirements of TSO C-129a Category A1. When using the GNC 300XL for non-precision approaches, you'll encounter two types of approaches: overlay approaches (based on existing procedures) and GPS approaches (new approaches designed specifically for GPS). The FAA has approved a large number of overlay approaches, with plans to add as many GPS approaches as possible to take advantage of the safety and convenience of GPS.

Flying a GPS approach is not difficult, and varies from conventional approaches only in the operation of the equipment being used. Although you'll often be following the same flight path used in conventional approaches, the equipment operation procedures will be different from typical NDB or VOR approaches.

The following definitions, guidelines and examples that follow will help you understand the basic rules of GPS approaches, and guide you through some typical approaches. Think through the approach examples— this will assist you in getting the greatest benefit from the GNC 300XL. There are a few basic rules that apply to all GPS approaches. Remembering these rules will assist you in understanding the approach procedures and ensure the greatest margin of safety for your flight.

- The approach to be flown must be in the aviation database, and the database must be current.
- You may select an approach any time after the destination airport is selected. If the GPS APR switch does not indicate an 'ARM' status within 2 nm inbound to the final approach fix, you run the risk of flying a non-approved approach.
- When performing an approach, the GPS SEQ switch must be set to the AUTO position with the FAF as the active to waypoint for the approach to go active. If the switch has not been set to the AUTO position 2 nm before the FAF, the CDI scale transition will be compressed, making the CDI change more abrupt.

(continued on the next page...)

APPROACH NAV

Basic Rules of GPS Approaches

SECTION 6

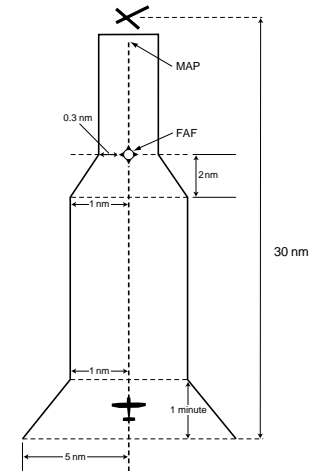

CDI Scale ramping during approach.

SECTION 6

APPROACH NAV Basic Rules of GPS Approaches

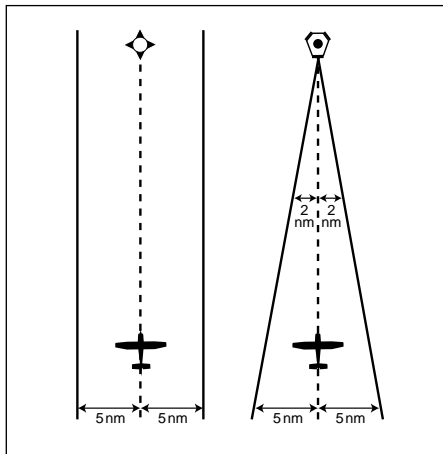

Unlike a VOR, GPS CDI deflection is based on the cross-track distance to the desired course, regardless of how far away you are from the destination.

- If you cross the same waypoint twice in succession during an approach (e.g., the IAF and FAF at the same waypoint, or radar vectors to the FAF), you must set the GPS SEQ switch to the HOLD position **prior** to crossing the fix the first time to prevent the GPS from sequencing to the next waypoint.
- During a GPS approach, keep in mind that your external HSI will display the same CDI needle deflection and scale as the CDI on the GNC 300XL, which will transition from 5.0 to 0.3 nm through the approach. Also note that unlike a VOR CDI, the GPS CDI scale is based on the **cross-track distance** to the desired course (the distance to the reference waypoint does not have an effect on the CDI scale, see illustration left).
- The HSI course select should always be set 2 seconds **before** changing the GPS SEQ from HOLD to AUTO to ensure the desired course to the next waypoint is settled prior to use by the GPS and give the autopilot sufficient time to react to the heading change.
- GPS always displays distance from the currently active waypoint. When determining distance along the approach, use caution to determine the correct distance from the approach chart.
- RAIM must be available (the GNC 300XL automatically monitors RAIM, and will display a message if it is not available) from the FAF to the MAP. If RAIM is not available or becomes unavailable during this leg, the HSI NAV flag will appear, and you must fly the missed approach procedure.
- When flying a missed approach, SID or STAR, you must fly all published procedures and ensure that all printed course and altitude restraints are achieved.
- If you are off course to the MAP waypoint and use a direct-to to re-center the d-bar, the active approach will be cancelled.
- SUA alerts are disabled when an approach is selected and armed and the aircraft is less than 30 nm from the destination airport. SUA information is still available from the NRST key at all times.

Flying A Typical Approach

The non-precision approaches available from the GNC 300XL will all follow the same general flow of events described below. Specific details and instructions relating to each step, along with several approach examples are provided later in this chapter.

1. Create a direct-to or route with an airport as the final destination

To save time during your flight, you may wish to create a route and select an approach before takeoff using the route catalog page.

2. Select an approach for the destination airport

An approach may be selected at any time, but must be loaded before reaching the final approach fix. Once an approach is selected, the approach waypoints will replace the destination airport and the GNC 300XL will provide navigation to the Initial Approach Fix.

3. Transition to the Arm Approach Phase

The GNC 300XL will automatically arm the approach 30 nm from the destination airport. The CDI scale will begin to ramp down from the 5.0 nm to the 1.0 nm scale, and the GPS APR annunciator will indicate an 'ARM' status.

4. Establish yourself on the final approach course

- No procedure turn approach– no special requirements
- Radar vectors– requires use of GPS SEQ switch to hold on designated approach waypoint
- Procedure turn– requires use of GPS SEQ switch to hold on active waypoint
- DME arc– requires use of position page to monitor distance from reference waypoint

(continued on the next page...)

APPROACH NAV Typical Approach Procedures

SECTION 6

```
118.30 124.30  
Goto KACY slct appr  
vor rw13?  
↓ vor rw22?
```

Select the approach.

GPS APR

GPS APR
ARM

The GNC 300XL will automatically arm the approach 30 nm from the destination airport.

SECTION

6

APPROACH NAV

Typical Approach
Procedures

```
136.97 118.00
WORLDWIDE IFR SUA
eff 27-feb-97 (9703)
exp 27-mar-97 ok?
```

GPS approaches must be in the current aviation database to be approved.

```
118.30 124.30
No RAIM FAF to MAP
```

TSO C-129a requires that satellite coverage and navigational accuracy provided by the GPS system meet minimum standards. A 'No RAIM from FAF to MAP' message will appear if RAIM is predicted to be unavailable for an approach. If you receive a RAIM message, continue the approach ONLY if the ACTV annunciator remains illuminated to the MAP. If the ACTV annunciator does not stay illuminated, your HSI NAV flag will appear, and you must fly the missed approach procedure.

5. Transition to Active Approach Phase

The approach will automatically transition to the active approach stage and the GPS APR annunciator will indicate an 'ACTV' status if the following conditions are met:

- The approach is armed
- The aircraft is 2 nm from the FAF on an inbound course
- The GPS SEQ switch is set to the 'AUTO' position
- The FAF is the active-to waypoint
- The GNC 300XL confirms that integrity monitoring will be available to complete the approach

Once the active approach phase begins, the CDI scale will begin to gradually transition from the 1.0 nm scale to the 0.3 nm scale, and remain at the 0.3 nm scale from the FAF to the MAP unless the approach is cancelled by pressing the external GPS APR switch, setting the GPS SEQ switch to 'HOLD' or by initiating a direct-to operation.

WARNING: You are not authorized to fly the final portion of the approach unless the external GPS APR annunciator indicates an 'ACTV' status.

6. Missed Approach Procedure

The GNC 300XL's automatic waypoint sequencing stops at the missed approach point. Once you have crossed the MAP, the GNC 300XL will give you the option of flying direct to the missed approach holding point:

- Press the GPS APR switch to return the CDI to the 1.0 nm scale.
- AFTER crossing the MAP, press **→**, followed by **ENT** to fly directly to the missed approach holding point.

WARNING! A direct course to the missed approach holding point may not correspond to the published missed approach procedure. Always fly all published procedures before selecting the holding fix on the GPS.

Selecting and Loading an Approach

When an arrival airport is selected with the direct-to key (or created and activated in a route to the arrival airport), the approaches for your arrival airport become available through the **approach select page**, which can be viewed by pressing **RTE** and rotating the outer knob. Remember that an airport must be the last waypoint in a route to select an approach.

To select an approach:

1. Select the destination airport using the **→** key, or create and activate a route to the destination airport (see Section 5).
2. Press **RTE** and rotate **○** to display the approach select page.
3. Rotate **●** (or **○** with the cursor active) to display the desired approach procedure.
4. Press **CRSR** twice (if necessary) and rotate **○** until the desired approach is highlighted.
5. Press **ENT** to select the approach.

If an approach procedure has more than one Initial Approach Fix (IAF), you'll need to select the desired IAF identifier for your approach.

To select an IAF:

1. Rotate **○** until the desired IAF is highlighted.
2. Press **ENT**.

Once the IAF is selected, the approach waypoints will be inserted into Route 0, replacing the destination airport, and the active route page will be displayed. To review the active route, rotate the **●** knob. The scrolling arrow prompt will indicate which direction to scroll to view additional waypoints, while the 'if', 'ff' and 'mp' designators will indicate the IAF, FAF and MAP respectively.



```
118.30 124.30
Rt 0 KACY slct iaf
  AVALO?
  BRIGS?
```

Select the Initial Approach Fix.

```
118.30 124.30
go to AVALO cum etc
  F→AVALO 912.4M 8:17
  ↓ :BAZES 922.0M 8:23
```

Once the approach is loaded, the active route page will appear.

SECTION

6

APPROACH NAV

Flying the Approach

```
118.30 124.30
CDI Settings
scale Auto ± 1.0nm
```

The GPS APR switch will indicate 'ARM' when the approach is armed. This will begin automatic CDI scale transitioning from 5.0 nm to 1.0 nm as you make your way to the FAF.

```
118.30 124.30
Nxt dtk 304° gs : 300k
dis 5.57nm dtk 062°
AVALO→BAZES etc 1:07
```

The 'Next dtk' prompt will flash to indicate the desired course for the leg of the approach route. Set the HSI course select to the next dtk value when the waypoint annunciator starts flashing.

When the aircraft is within 30 nautical miles of the destination airport, the GNC 300XL will automatically arm the approach, and the GPS APR switch will indicate an 'ARM' status.

To fly the GPS approach (without radar vectors):

1. Confirm that the GPS APR switch indicates an 'ARM' status. The CDI scale will begin a steady transition from the 5.0 nm to the 1.0 nm scale as you make your way to the FAF. If the approach has been disarmed and the aircraft is within 3 nm of the FAF, the GNC 300XL will prompt you to re-arm the approach.
2. The GNC 300XL will automatically sequence to each waypoint in the approach, with CDI, course and timing guidance to each waypoint. For each waypoint in the approach, the GNC 300XL's turn anticipation and waypoint alerting features will provide three pilot cues:
 - a. The waypoint annunciator will flash approximately 15 seconds before reaching the turning point for each approach waypoint, and glow steadily approximately 2 seconds prior to the turn anticipation point.
 - b. The 'Next dtk' prompt will flash in the CDI field when the 'WPT' annunciator begins flashing. Set the HSI course select to the next dtk value when the waypoint annunciator starts flashing. Start the turn when the annunciator glows steadily.
 - c. The To/From indicator flag on the GPS CDI will flip momentarily to indicate you have transitioned to the next approach leg.

For more information on turn anticipation and waypoint alerting, please refer to Section 5.

3. If a procedure turn is required:
 - a. 2 miles prior to crossing the waypoint outbound, set the GPS SEQ switch to HOLD.
 - b. At the waypoint, set the outbound course on the HSI.
 - c. Fly the procedure turn. After the procedure turn outbound, set the inbound course on the HSI.
 - d. On the inbound intercept to the final course, fly to center the CDI.

(continued on next page)

- e. Set the GPS SEQ switch to the AUTO position. The GNC 300XL will resume automatic waypoint sequencing for the remaining approach waypoints.
4. Once the aircraft is within 2 nm of the FAF (and the approach is armed), the 'ACTV' annunciator will illuminate and the CDI scale will ramp down to 0.3 nm.
NOTE: If the ACTV annunciator does not illuminate, do not descend after crossing the FAF and fly all published missed approach procedures.
5. Upon reaching the FAF, the GNC 300XL will automatically sequence to the MAP waypoint.

To fly a missed approach procedure:

If an approach is terminated, the GNC 300XL may be used to navigate to the missed approach holding point using one of the following procedures.

NOTE: To comply with TSO specifications, the GNC 300XL will not automatically sequence to the missed approach holding point. The missed approach holding point will be displayed as the next available waypoint, which the pilot may activate when authorized. You must fly all published missed approach procedures before selecting the missed approach holding point on the GPS. If you want to disarm the approach and return the CDI scale to the 1 nm sensitivity, press the GPS APR switch.

If the approach procedure permits navigation direct from the MAP to the missed approach holding point:

1. After the MAP has been crossed, press the **→** key. The GNC 300XL will automatically display the first waypoint of the missed approach as the next approach waypoint.
2. Press **ENT** to confirm the destination. The GNC 300XL will provide a direct navigation course to the waypoint.



APPROACH NAV SECTION 6

Flying the Approach

```
118.30 124.30
go to int:SMITS
N39°29.25' W074°20.59'
auto crs:091° ok?
```

After crossing the MAP, press the **→** key to display the missed approach holding point.

```
118.30 124.30
+++++↑+++++ gs :110K
dis 10.47M dtk 092°
go to:SMITS ete 7:20
```

If you have clearance directly to the holding point, press **ENT**. You must fly all published missed approach procedures before navigating to the holding point.

SECTION

6

APPROACH NAV

Missed Approach

```

118.30 124.30
go to SMITS cum ete
  F: AVALO -----M-----:--
↑ : BAZES -----M-----:--
  
```

Select the waypoint you have clearance to on the active route page and press **→**.

```

118.30 124.30
go to int:BAZES
  N39° 23.21' W074° 21.42'
auto crs:133° OK?
  
```

Confirm the starting waypoint for the next attempt by pressing **ENT**.

If you're not authorized to fly direct-to the missed approach holding point:

1. After the MAP has been crossed, press the **→** key. The GNC 300XL will automatically display the first waypoint of the missed approach procedure as the next approach waypoint.
2. Press **ENT** to confirm the destination.
3. Stop automatic waypoint sequencing by setting the GPS SEQ switch to the HOLD position.
4. Fly the missed approach procedure. Remember to select the desired inbound course to the missed approach holding point before setting the GPS SEQ switch to the AUTO position.
5. Set the GPS SEQ switch to the AUTO position for navigation to the missed approach holding point.





After a missed approach, the GNC 300XL will allow you to repeat the same approach procedure and select the approach waypoint to which you have been cleared as the next active to waypoint. Before reactivating the approach, make sure you fly all published missed approach procedures.

To reactivate the same approach for another attempt:

1. Press the **RTE** key and rotate **○** to select the active route page.
2. Press **CRSR** twice and rotate **○** to place the cursor over the identifier of the approach waypoint to which you have been given clearance.
3. Press the **→** key, followed by **ENT**. The GNC 300XL will provide navigation for the repeat approach, starting with the approach waypoint you have selected.





The GNC 300XI's **approach select page** allows you to review the available approach procedures at the destination airport. From the procedures list, you may select and activate a new procedure on the fly. The active approach is indicated by an on-screen asterisk, and the scrolling arrow prompt indicates which direction to scroll to view additional procedures.

To select or replace a procedure from the approach select page:

1. Press the **RTE** key and rotate  until the approach select page appears.
2. To review all available procedures, rotate . "UNKN" (unknown) is displayed on the approach select page when the unit software does not how to display a new approach type in the database. **DO NOT USE THIS APPROACH TYPE.**
3. To select a procedure, press **CRSR** twice and rotate  to highlight the desired procedure.
4. Press **ENT**. If there are multiple IAFs for the selected approach, rotate  to select the desired IAF and press **ENT**.

You may also replace or delete the active approach from the route catalog page.

To replace or delete an approach from the route catalog page:

1. Press the **RTE** key and rotate  until the route catalog page appears.
2. Press **CRSR** twice and rotate  until the 'approach?' prompt appears. Press **ENT**.
3. To replace the active approach procedure, rotate  to highlight the desired procedure and press **ENT**. If there are multiple IAFs for the selected approach, rotate  to select the desired IAF and press **ENT**.
4. To delete the active approach (denoted by an asterisk), highlight the approach and press **CLR**, followed by **ENT**.



```
118.30 124.30
Rt 0 KACY *actv appr
vor rw22?
↑*vor rw31.AVALO
```

Approach Select Page

```
118.30 124.30
Rt 0 KACY *actv appr
vor rw22?
↑*████████████████████
```

The Approach Select Page after deleting the active approach. If direct-to navigation to a SID/STAR/Approach waypoint is active when the procedure is deleted, the direct-to waypoint will be retained as an "off route" destination.

SECTION

6

APPROACH NAV

GPS Approach
Examples

GPS APPROACH EXAMPLES

In the examples that follow, the GPS waypoints are shown along the approach path. In some cases, intermediate database waypoints have been added to approaches. These waypoints are named using lower case letters using the following convention (the most common database waypoints are defined below). Note that these waypoints are not charted on NOS approach plates. They do appear on current Jeppesen approach charts.

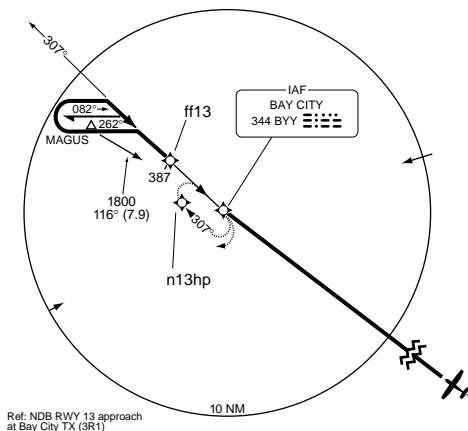

- **dyyyj**— DME arc waypoint where yyy is the radial from the reference facility (VOR) and j represents the arc radius (e.g., “a”= 1 nm, “b”= 2 nm, etc.)
- **cfxx or cfxxx**— course fix for runway xx or radial xxx
- **ffxx or ffxxx**— final approach fix for runway xx or radial xxx
- **rwxx**— runway xx threshold
- **nxxhp**— NDB approach runway xx intermediate holding pattern waypoint
- **maxx or maxxx**— missed approach point for runway xx or radial xxx
- **vxxhp**— VOR approach runway xx intermediate holding pattern waypoint

APPROACH NAV



GPS Only

Approach Example

SECTION 6

EXAMPLE 1— GPS ONLY APPROACH

Example 1 uses the GPS approach into Frederick Municipal Airport (KFDK) and illustrates the basic sequence of selecting and flying a GPS approach, and flying directly to a missed approach holding point. Please refer to the previous sections of this chapter for expanded keystroke instructions.

1. Select the destination airport (KFDK) using the  key, or create and activate a route to the destination airport.
2. Select the desired approach (GPS RW05) from the approach select page. The GNC 300XL will automatically select MRB as the IAF since it is the only IAF available.
3. Confirm that the GPS APR switch indicates an 'ARM' status 30 nm from the airport. The CDI will automatically begin a smooth transition from the 5.0 nm to the 1.0 nm scale.
4. Fly the approach. The GPS will provide navigation to each approach waypoint in sequence:
 - MRB (initial approach fix)
 - SUSII
 - BAKEE (final approach fix)
 - MYRTA (missed approach point)
 - RUSSY (missed approach holding point)
5. Set the HSI course to DTK at each waypoint. Confirm that the GPS APR switch indicates an 'ACTV' status within 2 nm of the FAF (BAKEE). The CDI will automatically transition from the 1.0 nm to 0.3 nm scale as you approach the FAF, and the unit will warn you if RAIM is not available for your approach.
6. Complete the approach by landing or perform the missed approach procedure.
7. For direct navigation guidance to the missed approach holding point (RUSSY), press  followed by  after crossing the MAP (MYRTA).

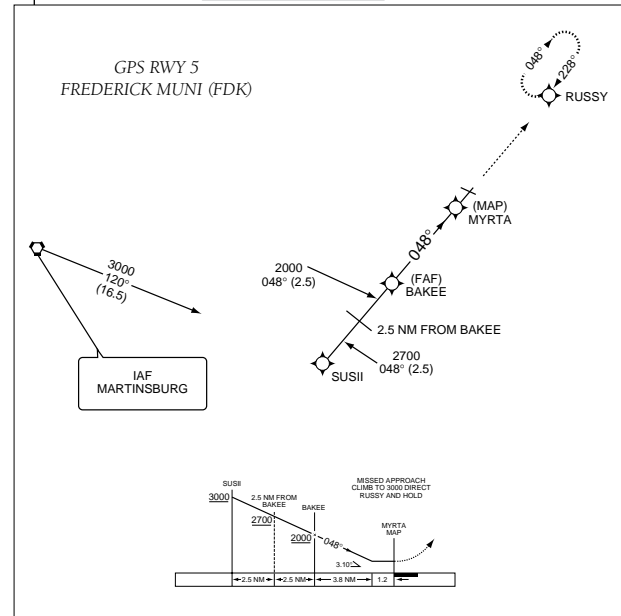

DO NOT USE FOR NAVIGATION

SECTION 6

APPROACH NAV VOR/GPS Overlay Example

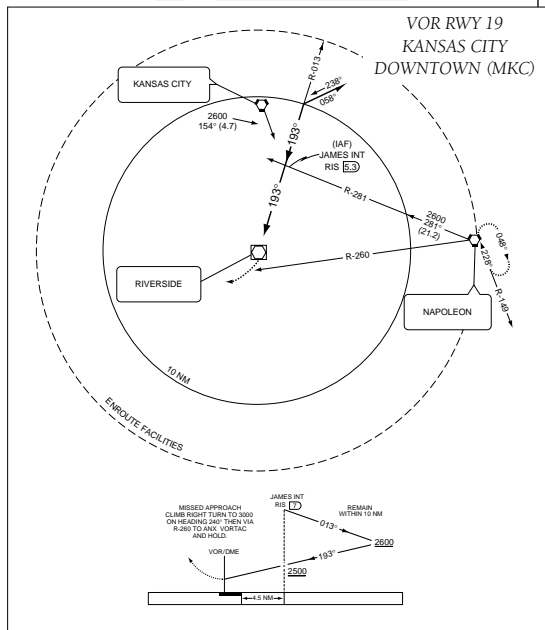

DO NOT USE FOR NAVIGATION

EXAMPLE 2 – VOR/GPS OVERLAY APPROACH

Example 2 uses the VOR/GPS RWY 19 approach into Kansas City Downtown Airport (KMKC) from the south and illustrates an approach with a procedure turn, which requires the pilot to set the GPS SEQ switch to the HOLD position prior to crossing the IAF the first time. This example also illustrates the procedures required when direct navigation to the missed approach holding point is not available.

1. Select the VOR/GPS RWY19 approach and confirm that the GPS APR switch indicates an 'ARM' approach status.
2. Fly towards the IAF (JAMES) of the approach.
3. Two nautical miles **before** crossing the IAF, set the GPS SEQ switch to the HOLD position. This prevents the GNC 300XL from automatically sequencing to the MAP (Riverside) before the required procedure turn is completed.
4. After crossing the IAF, set the 013° outbound course on the HSI.
5. Initiate the procedure turn and set the 193° inbound course on the HSI. As you turn to the inbound intercept heading, set the GPS SEQ switch to the AUTO position. The GPS SEQ switch must be set to the AUTO position for the approach to go active.
6. Confirm that the GPS APR switch indicates an 'ACTV' approach status within 2 nm of the FAF. Complete the approach by landing, or follow the missed approach procedure.
7. To fly the missed approach procedure, cross the MAP (Riverside), climb to 3000 feet via heading 240° and press **→** followed by **ENT**. This will select the missed approach holding point (ANX) as your 'active to' waypoint.
8. Since direct navigation to the holding waypoint is not authorized, set the GPS SEQ switch to the HOLD position to prevent automatic waypoint sequencing.
9. Set the HSI to the 080° heading and turn left to intercept the inbound course to the holding point.

EXAMPLE 3 – VOR/DME ARC OVERLAY APPROACH

Example 3 uses the VOR/DME RWY 21 approach into Topeka/Forbes Field Airport (KFOE) and illustrates an approach based on a DME arc. Although DME arc approaches are not based on a direct course, the GNC 300XL will still provide approach navigation guidance through the arc by constantly displaying your distance and bearing from the DME reference navaid on the **position page**. To fly the arc, monitor the distance displayed on the position page and manually adjust your heading to maintain the course along the arc. When flying a DME arc, the GPS SEQ switch must be set to the HOLD position to ensure proper CDI operation.

1. Select the VOR RWY21 approach and select the D094G initial approach fix to fly the left hand arc from the 094° radial. Thirty nautical miles from the airport, confirm that the GPS APR switch indicates an 'ARM' status.
2. Fly towards the IAF (D094G). The GPS WPT annunciator will flash 15 seconds before you reach the waypoint.
3. After crossing the IAF, set the GPS SEQ switch to the HOLD position.
4. Set the desired inbound course (205°) on the CDI/HSI.

```

118.30 124.30
alt 1080f prs: 30.03M
N39° 07.260' W095° 24.099'
r wpt: TOP 093° 6.94M
    
```

5. Press **NAV** and rotate **⊙** to display the position page. The position page will display the DME navaid as the reference waypoint (on the bottom line) as long as your 'active' waypoint is part of the DME arc you are flying.

(continued on next page)

APPROACH NAV VOR/DME Arc Example

SECTION 6

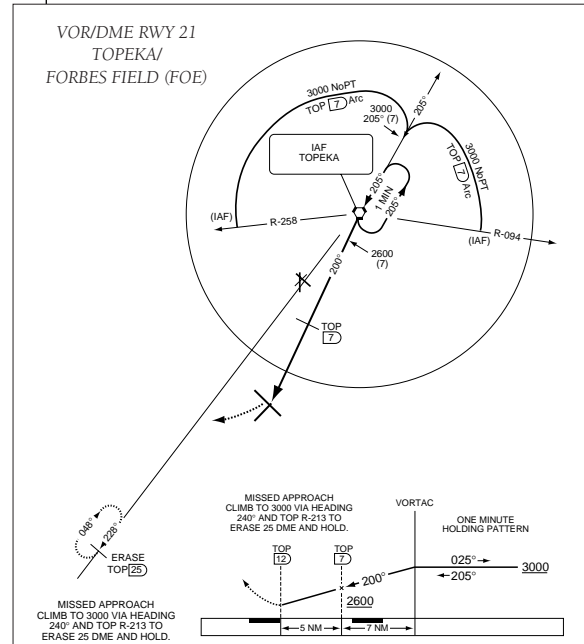

DO NOT USE FOR NAVIGATION

SECTION 6 APPROACH NAV

VOR/DME Arc Example

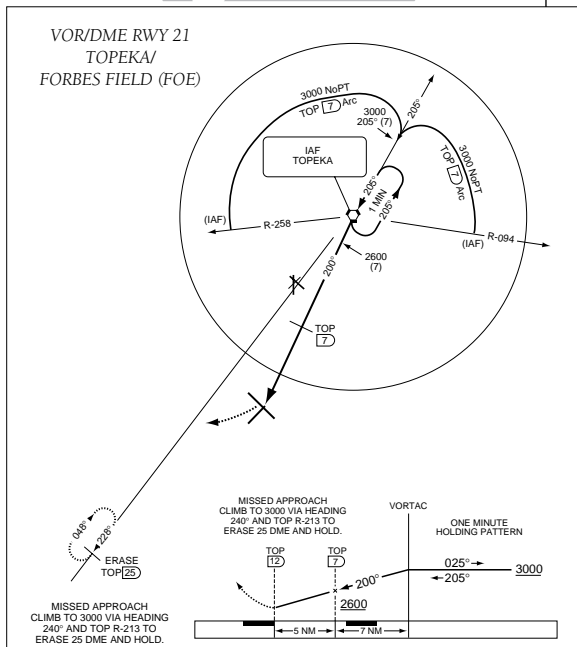

6. Monitor your distance and bearing from the DME navaid along the arc.
7. The external CDI course deviation needle will begin to center as you approach the inbound course. The GPS WPT annunciator will flash 15 seconds before reaching the course fix, and the desired track for the final approach will appear in place of the graphic CDI.

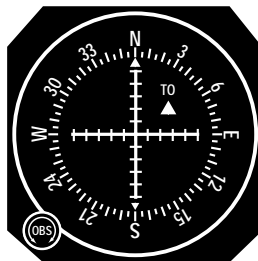

GPS SEQ
AUTO

8. Dial in the final course (200°) on the HSI and set the GPS SEQ switch to the AUTO position. Automatic waypoint sequencing will resume for the rest of the approach. Locate the step down fix by monitoring the distance to the MAP as shown on the profile view of the approach plate. Confirm that the GPS APR switch indicates an 'ACTV' status 2 nm from the FAF.
9. To fly the missed approach procedure, cross the MAP and climb to 3000 feet via heading 240°.
10. Press **ERASE**, followed by **ENT**. This will select the missed approach holding point (ERASE) as your 'active to' waypoint.
11. Place the procedure on HOLD by pressing the GPS SEQ switch.
12. Set the HSI to the 213° course, fly until the CDI is centered and enter the holding pattern.

EXAMPLE 4— RADAR VECTORS TO FINAL APPROACH COURSE

Example 4 uses the same VOR/DME RWY 21 approach into Topeka/Forbes Field Airport (KFOE) used in Example 3 and illustrates an approach using radar vectors to a point 3 miles out from the final approach fix. To fly a radar vector approach, you must still select a desired approach and IAF from the database and set the GPS SEQ switch to HOLD while you fly the vectors to the active approach waypoint. To accommodate radar vectors, the GNC 300XL allows manual selection of any approach waypoint as the destination waypoint.

1. Select the desired approach and initial approach fix. Thirty nautical miles from the airport, confirm that the GPS APR switch indicates an 'ARM' status.
2. When you are advised by the controller that you will be receiving radar vectors to the final approach course:
 - Activate the final approach fix waypoint from the active route page:
 - a. Press the **RTE** key and rotate **○** until the active route page appears.
 - b. Rotate **●** until 'ff21' is displayed.
 - c. Press **CRSR** twice to activate the cursor.
 - d. Rotate **○** until 'ff21' is highlighted.
 - e. Press **→**, followed by **ENT**.
 - Set the GPS SEQ switch to the HOLD position.
3. Set the 200° inbound course on the HSI. As the CDI needle begins to center to the final approach course, set the GPS SEQ switch to the AUTO position.
4. Confirm that the GPS APR switch indicates an 'ACTV' status 2 nm from the FAF. Complete the approach by landing or perform the missed approach procedure.

APPROACH NAV

Radar Vector Example

SECTION 6

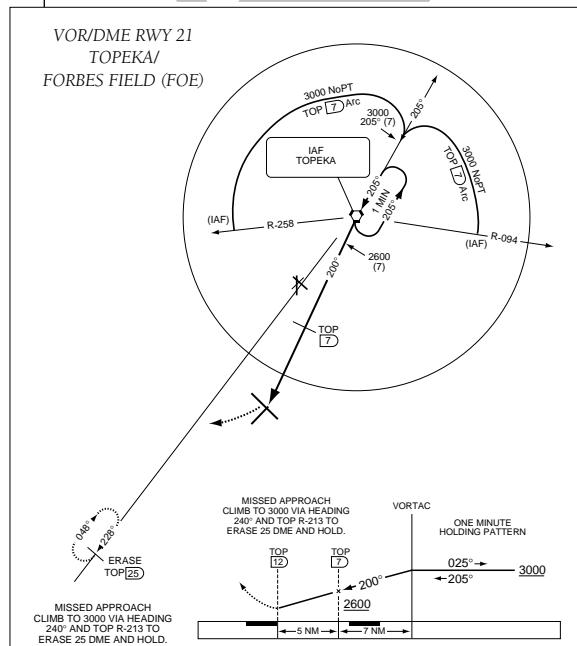

DO NOT USE FOR NAVIGATION

SECTION

6

APPROACH NAV

Selecting &
Activating SIDs

```
118.30 124.30
Rt 0 KIXD slct sid
  CHIEF2?
↓ LAKES3?
```

Selecting a SID.

```
118.30 124.30
Rt 0 CHIEF2 slct trn
  ANGEY?
  STJ?
```

Selecting a SID transition.

The Jeppesen database used in the GNC 300XL features **standard terminal arrival routes** (STARs) and **standard instrument departures** (SIDs) that may be placed into any active or stored route.

Available SIDs may be selected for the departure airport at any time in the active route as long as the departure airport is the first route waypoint and the route contains more than one waypoint. SIDs may be selected for the nearest airport when the first route waypoint is not an airport or the route contains less than two waypoints. Activating a SID will modify the waypoint sequence of Route 0. If you'd like to save the contents of Route 0, be sure to copy it to an empty storage route first.

To select and activate a SID:

1. Press **RTE** and rotate until the SID select page appears.
2. With the cursor inactive, rotate until the desired SID name appears.
3. Press **CRSR** twice and rotate until the SID name is highlighted.
4. Press **ENT**. The SID waypoints will be inserted in the route.

If a SID has more than one runway or transition, the SID select page will display the available runway designations and/or transitions.

To select a transition:

1. Rotate until the transition name is highlighted and press **ENT**.

To select a runway:

1. Rotate until the runway designation name is highlighted and press **ENT**.

The SID select page also allows you to review all the available SIDs for the departure airport and select, delete or change the active SID.

To replace/delete the active SID:

1. Press **RTE** and rotate **○** until the SID select page appears.
2. Press **CRSR** twice. The active SID (denoted by an asterisk) is highlighted.
3. To replace the active SID with another available SID, rotate **○** to highlight the desired SID. Complete the selection by pressing **ENT**.
4. To delete the active SID, press **CLR**, followed by **ENT**. The SID waypoints will be removed from the active route.

SIDs can also be selected and deleted from storage routes through the Route Catalog page.

To select a SID from the route catalog page:

1. Display the desired route on the route catalog page.
2. Select 'sid?' in the route operations field and press **ENT**.
3. Select the desired SID and transitions.
4. The SID waypoints will be inserted into the route and the route review page will be displayed.

To delete a SID from the route catalog page:

1. Display the desired route on the route catalog page.
2. Select 'sid?' in the route operations field and press **ENT**.
3. Rotate **○** to highlight the selected SID (denoted by an asterisk). Press **CLR**, then **ENT**.

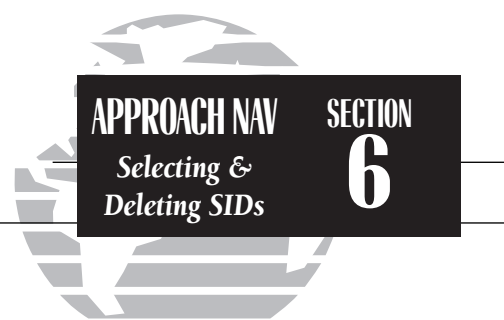

```
118.30 124.30
Rt 0 KIXD *actv sid
*ALL.CHIEF2.ANGEY
↓ LAKES3?
```

The SID select page allows you to select a new SID on the fly.

```
118.30 124.30
Rt 6 KIXD slct sid
CHIEF2?
↓ LAKES3?
```

SIDs may be saved with any stored route.

SECTION

6

APPROACH NAV

Selecting &
Activating STARS

```

118.30 124.30
Rt 0 KMCI slct star
  BRAMR2?
↓ JHAWK2?

```

Selecting a STAR.

```



118.30 124.30
Rt 0 JHAWK2 slct trn
  CNU?
  EMP?

```

Selecting a STAR transition.

Standard Terminal Arrival Routes (STARs) used in the GNC 300XL are selected and activated with the same procedures as SIDs. Available STARs may be selected for the destination airport at any time in the active route as long as the destination airport is the last waypoint in the active route or the direct-to waypoint. Activating a STAR will modify the sequence of waypoints in Route 0. If you'd like to save the contents of Route 0, be sure to copy it to an empty storage route first.

To select and activate a STAR:

1. Press **RTE** and rotate  until the STAR select page appears.
2. Press **CRSR** and rotate  until the desired STAR is highlighted.
3. Press **ENT**. The STAR waypoints will be inserted in the route.

If a STAR has more than one transition or runway, the STAR select page will display the transitions and/or runway designations available.

To select a transition:

1. Rotate  until the desired transition is highlighted and press **ENT**.

To select a runway:

1. Rotate  until the runway designation is highlighted and press **ENT**.

The STAR select page also allows you to review all available STARs for the destination airport and select, delete or change the active STAR.

To replace/delete a STAR:

1. Press **RTE** and rotate **○** until the STAR select page appears.
2. Press **CRSR** twice. The active STAR (denoted by an asterisk) is highlighted.
3. To replace the active STAR with another available STAR, rotate **○** to highlight the desired STAR. Complete the selection by pressing **ENT**.
4. To delete the active STAR, press **CLR**, followed by **ENT**. The STAR waypoints will be removed from the active route.

STARs can also be selected and deleted from storage routes through the route catalog page.

To select a STAR from the route catalog page:

1. Display the desired route on the route catalog page.
2. Select 'star?' in the route operations field and press **ENT**.
3. Select the desired STAR and transitions.
4. The STAR waypoints will be inserted into the route and the route review page will be displayed.

To delete a STAR from the route catalog page:

1. Display the desired route on the route catalog page.
2. Select 'star?' in the route operations field and press **ENT**.
3. Rotate **○** to highlight the selected STAR (denoted by an asterisk). Press **CLR** followed by **ENT**. The STAR waypoints will be deleted from the route.

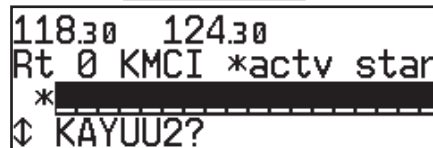

Deleting the active STAR.

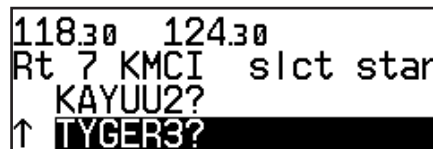

STARs may be saved in any storage route.

SECTION 7 UNIT SETTINGS

Messages Settings Submenus

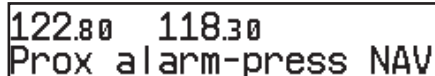

122.80 118.30
Prox alarm-press NAV

To view a message, press .

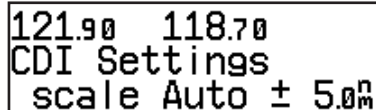



121.90 118.70
CDI Settings
scale Auto ± 5.0m

To access the settings submenu pages, press and hold the  key for two seconds. The GNC 300XL will return to the last submenu viewed the next time you access the unit settings.

Section 7

Messages and Unit Settings

The GNC 300XL's  key provides access to system messages and allows you to customize the unit to your own preferences through a settings submenu. Whenever the GNC 300XL needs to alert you to a navigation, communication or system message, the annunciator light () next to the  key will flash. Some messages are advisory in nature (e.g., the arrival and countdown alarms), while others may require your immediate attention (e.g., a stuck microphone message). For a complete list of GNC 300XL messages, please see Appendix D.

To view a message, press . Press  again to return to the previous page.

The GNC 300XL's settings submenu is also accessed from the  key.

To view the settings submenu, press and hold  for more than two seconds.



Once the settings submenu has been accessed, the following setup pages are available by rotating  with the cursor inactive:

- Map page settings
- Nearest airport search
- Battery saver
- Backlighting settings
- Navigation units
- Map datums
- CDI scale settings
- Mag. var./arrival alarm settings
- Display screen settings
- Trip timer settings
- SUA settings
- I/O Settings (channel 2 only)

The GNC 300XL's map page is designed to be a flexible tool that can be customized to your navigation needs. The **map setup page** provides access to many of the features and functions that will help you configure the map page to your own preferences. From the map setup page you can set the map orientation, automatic zoom, and specify which waypoints and airspace boundaries you wish to display.



The map orientation setting allows you to orient the top of the map display to your current ground track ('trk up'), fix the top of the map to north like a paper chart ('nrth up') or set the top of the map along your desired track ('dtk up').

To change the map orientation:

1. Press and hold **MSG**, then rotate  to select the 'MAP Setup' page.
2. Press **CRSR** twice to highlight the orientation field.
3. Rotate  to select 'trk up', 'dtk up' or 'nrth up'.

The automatic zoom feature will automatically adjust the map display scale during your flight. Starting at an en route scale of 300 (nautical miles, statute miles or kilometers) the scale will adjust through each lower scale, stopping at a scale of 1 as you approach your destination waypoint.

To turn the automatic zoom feature on or off:

1. Press and hold **MSG**, then rotate  to select the 'MAP Setup' page.
2. Press **CRSR** twice and rotate  to highlight the 'auto zoom' field.
3. Rotate  to select 'on' or 'off'.

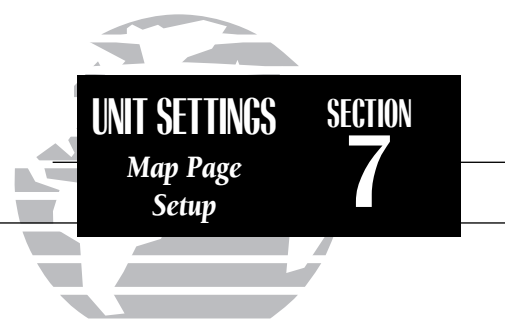

```
121.90 118.70
MAP Setup
orientation trk up
auto zoom on↓
```

Map setup page

```
121.90 118.70
MAP Setup
orientation nrthup
auto zoom on↓
```

The map orientation may be set to north up, track up or desired track up. This determines what direction the top of the map display is oriented to.

SECTION

7

UNIT SETTINGS

Map Page
Setup

```

121.90 118.70
MAP Setup
orientation nrthup
auto zoom on↓

```

The automatic zoom feature will automatically adjust the map display through progressively lower scale settings as you approach your destination waypoint.

```

121.90 118.70
MAP Setup
apt ■ 200M
apt ident 20M↕

```

A scale setting of '200' for airports will display airport locations on the map display for all scales from '200' on down. Airports will not appear on the map display at a scale setting of '300'.

The map setup page also allows you to control whether or not the various waypoint types and the identifiers for these waypoints are displayed. Settings for each waypoint type allow you to select the maximum scale at which that feature should be displayed, or you may turn that waypoint type off for all scales. For example, by setting 'VOR' at 80, VOR waypoints will appear on the map display at all scales from 80 on down, but not at 120, 200 or 300.

To display airports, nav aids and/or user waypoints:

1. Press and hold **MSG**, then rotate **○** to display the 'MAP Setup' page.
2. Press **CRSR** twice and rotate **○** to highlight 'apt', 'vor', 'ndb', 'int' or 'user'.
3. Rotate **○** to select the maximum map scale for that waypoint type, or select 'off' to disable the waypoint type entirely.

To display waypoint identifiers:

1. Press and hold **MSG**, then rotate **○** to display the 'MAP Setup' page.
2. Press **CRSR** twice and rotate **○** to highlight 'apt ident', 'vor ident', 'ndb ident', 'int ident', or 'user ident'.
3. Rotate **○** to select the maximum map scale for that waypoint category, or select 'off' to disable the waypoint identifiers.

The boundaries for airspaces that appear on the map display may be enabled or disabled by airspace type. As described above for waypoints, you select the maximum scale at which the airspace should appear or turn the airspace type off entirely. Airspace categories for Class B/CTA, Class C/TMA, MOA, restricted and other SUAs are provided. 'Other sua' includes alert, caution, danger, training and warning areas.

To enable/disable airspace boundaries on the map:

1. Press and hold **MSG**, then rotate **○** to select the 'MAP Setup' page.
2. Press **CRSR** twice and rotate **○** to highlight 'class B/cta', 'class C/tma', 'moa', 'restricted' or 'other sua'.
3. Rotate **●** to select the maximum map scale for the designated airspace type, or select 'off' to never display.

The next page under the settings submenu is the **CDI settings page**, which allows you to define the scale of the GNC 300XL's course deviation indicator.

To change the CDI scale:

1. Press and hold **MSG**, and rotate **○** to select the 'CDI Settings' page.
2. Press **CRSR** twice and rotate **●** to select 'Auto', '+5.0 nm', '+1.0 nm' or '+0.3 nm'.
3. Rotate **○** to highlight 'ok?' and press **ENT** to approve.
(Note: the selected CDI scale will not take effect until approved.)

The scale values represent full scale deflection of the CDI to either side. The default setting is 'Auto'. The 'Auto' setting will start the CDI scale at 5 nm (en route), and gradually ramp the scale down to the 1 nm range once you are within 30 nm of a departure or arrival airport (terminal area). For auto CDI scaling to occur, you must have an active direct-to or route with an airport as your final destination waypoint, or be within 30 nm of a departure airport. Note that the **Receiver Autonomous Integrity Monitoring (RAIM)** protection limits listed below follow the selected CDI scale, changing automatically with the 'Auto' setting:

| CDI Scale | RAIM Protection |
|-------------------------------|-----------------|
| +/-5.0 nm or Auto (en route) | 2.0 nm |
| +/- 1.0 nm or Auto (terminal) | 1.0 nm |
| +/- 0.3 nm or Auto (approach) | 0.3 nm |

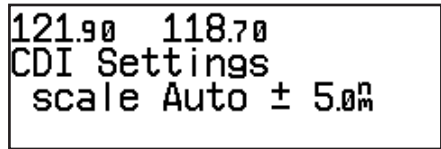
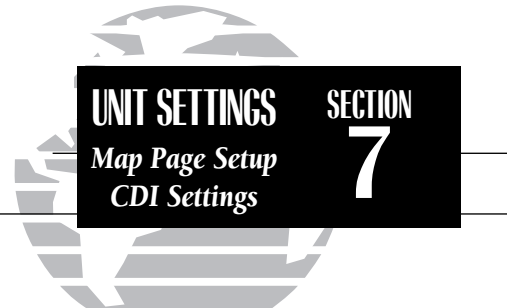

When the 'auto' CDI setting is selected, the GNC 300XL will automatically change the CDI scale when you are within 30 nm of a departure or arrival airport. The CDI setting will be reset to 'Auto' during approach operations, to provide a smooth CDI transition from 5.0 nm to 0.3 nm scales.



The 'auto mag' setting will automatically calculate the magnetic variation based upon your current position.

SECTION

7

UNIT SETTINGS

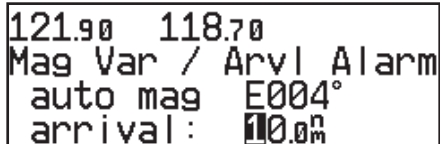
Magnetic Variation
Arrival Alarm

121.90 118.70
Mag Var / Arvl Alarm
auto mag E004°
arrival: 10.0n

Setting the arrival alarm to 10 nautical miles.

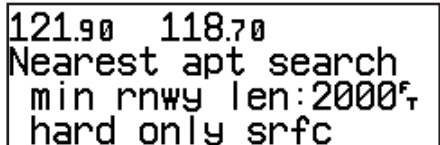

121.90 118.70
Nearest apt search
min rnwy len: 2000ft
hard only srfc

The runway length and surface type settings allow pilots of large, high-performance aircraft to direct the **NRST** key function to ignore those airports at which it would be difficult, if not impossible, to land their aircraft.

The GNC 300XL has three **magnetic variation options**: true, auto, or user-defined.

To set the magnetic variation:

1. Press and hold **MSG**, and use to display the 'Mag Var/Arvl Alarm' page.
2. Press **CRSR** twice and use to select 'auto mag', 'true hdg' or 'user mag'.
3. If user is selected, use to highlight the magnetic variation value, and use and to enter the value and 'E' or 'W'. Press **CRSR** to finish.

If 'auto' mag var is selected, all track, course and heading information will be corrected to the magnetic variation computed by the GPS receiver. The 'true' setting will reference all information to true north, and the 'user' setting will correct information to an entered value.

The GNC 300XL's **arrival alarm** can be set to notify the pilot with a message when you have reached a user defined distance to a final destination waypoint (the direct-to waypoint or the last waypoint in a route). Once you have reached the set distance (up to 99.9 units), an 'Arrival at ____' message will be displayed.

To set the arrival alarm distance:

1. Press and hold **MSG**, and use to display the 'Mag Var/Arvl Alarm' page.
2. Press **CRSR** twice and use to select the arrival distance field.
3. Use and to enter the desired distance. Press **CRSR** to finish.

The **nearest airport search** settings allow you to define the runway length and surface type used in determining the nine nearest airports displayed. A minimum runway length and surface type may be entered to prevent airports with small runways, or runways that are not of appropriate surface, from being displayed. The default settings are '0 ft/mt' for runway length and 'any' for runway surface type.

To set the minimum runway length and runway surface:

1. Press and hold **MSG** and use **○** to display the 'Nearest apt search' page.
2. Press **CRSR** twice and use **●** and **○** to enter the minimum runway length upon which your aircraft can land (up to 9999 units). Press **ENT** to accept the distance.
3. Rotate **●** to display the surface selection you desire. Choices include:
 - any surface
 - hard only surface
 - soft/hard surface
 - water only surface
4. Use **○** to select 'ok?' and press **ENT** to confirm.

The GNC 300XL's **battery saver feature** can be programmed to automatically turn off the backlighting when using the optional remote battery pack. This will increase the remote battery life in the event of power failure. During this time, the GNC 300XL will continue to navigate and track satellites, but will not backlight the display until a key is pressed or a knob is turned.

To set the display timeout:

1. Press and hold **MSG** and rotate **○** to display the 'Battery saver' page.
2. Press **CRSR** twice to activate the cursor.
3. Rotate **●** until the desired value is displayed (0, 30, 60 or 90 seconds). Entering 0 will leave the display on at all times. Press **CRSR** to finish.

The GNC 300XL features automatic contrast and backlighting control to adjust the display for optimum viewing in any condition. This is done using a photocell at the top left corner of the display bezel. It is important that this photocell not be covered to ensure proper display adjustment. You may also select manual control of the display contrast and backlighting to tailor the GNC 300XL to your needs.

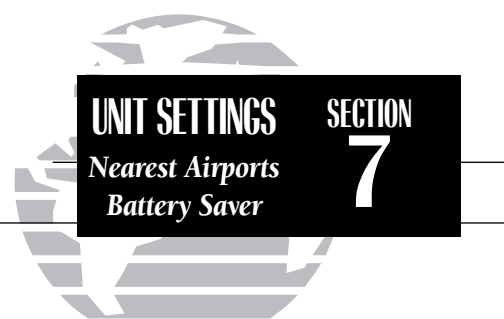

A rectangular display area showing the following text: '121.90 118.70' on the first line, 'Battery saver--turn' on the second line, 'off backlight 30 s' on the third line, and 'after last keypress' on the fourth line.

Display timeout settings. As shown, the display backlight will turn off after 30 seconds to conserve power in the optional battery pack.

SECTION 7

UNIT SETTINGS

Display Settings

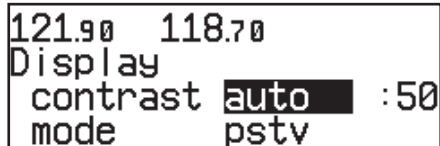

121.90 118.70
Display
contrast auto :50
mode pstv



The display contrast may be set to automatically adjust to varying lighting conditions, using the built-in photocell.



121.90 118.70
Display
contrast auto :50
mode ngtv





Setting the display mode to 'negative' will display on-screen characters as light green on a black background. This setting is suitable for night operation.

To change the display contrast settings:

1. Press and hold **MSG** and rotate  to show the 'Display' settings page.
2. Press **CRSR** twice and use  to select 'auto' or 'manual' control.
3. Press **ENT**.
4. If 'manual' is selected, use  to set the display contrast level. (If 'auto' is selected you may also change the offset level to your preference.)
5. Press **CRSR** to complete.

The 'mode' selection allows you to display on-screen characters as black on a light green background (positive) or light green on a black background (negative). With the 'auto' setting the photocell selects the best mode for day or night viewing.

To change the display mode settings:

1. Press and hold **MSG** and rotate  to show the 'Display' settings page.
2. Press **CRSR** twice and use  to highlight the 'mode' field.
3. Rotate  to select 'pstv', 'ngtv' or 'auto'.
4. If 'auto' is selected, rotate  to highlight the threshold level, and use  to select the level at which the display will switch from positive to negative for night time use. (Note: Some experimentation may be necessary to obtain the desired response level.)

The backlight intensity settings control the backlighting level and allow for automatic adjustment using the built-in photocell or manual adjustment.

To change the backlighting intensity:

1. Press and hold **MSG**, and rotate **○** to display the 'Backlight intensity' page.
2. Press **CRSR** twice to highlight the 'mode' field.
3. Rotate **●** to select 'auto' or 'manual'.
4. If 'manual' is selected, rotate **○** to highlight the 'level' field, and use **●** to select the desired backlighting level.

The **trip timer** provides a running clock on NAV Menu 2 (see page 29), and can be configured to run when power is on or when your ground speed exceeds a user-defined minimum.

To change the trip timer settings:

1. Press and hold **MSG**, and use **○** to display the 'Trip timer settings' page.
2. Press **CRSR** twice to activate the cursor.
3. Use **●** to select either 'pwr is on' or 'gs exceeds'.
4. If you choose 'pwr is on', press **CRSR** to complete.
5. If you choose 'gs exceeds', use **○** to highlight the speed field.
6. Enter the speed using **●** and **○**.
7. Press **ENT** to accept, and press **CRSR** to complete.



121.90 118.70
Backlight intensity
mode auto
level 75%

The backlight intensity settings page is used to set/adjust the screen backlighting for day or night time operation.

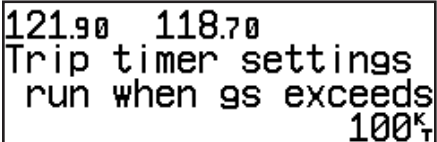

121.90 118.70
Trip timer settings
run when gs exceeds
100%

Trip timer settings, showing timer active when groundspeed exceeds 100 knots.

SECTION

7

UNIT SETTINGS

Units of Measure

```

121.90  118.70
posn dm  alt  fT fpm
nav  nm kT fuel  gL
pres  h9  temp  °f
    
```

Default units of measure settings.





```

121.90  118.70
posn dm  alt  mT mpm
nav  km kh fuel  lT
pres  mb  temp  °c
    
```

Units of measure settings with all metric values displayed.

The GNC 300XL can be configured to display data in standard or metric **units of measure**. These apply to: distance, position, speed, altitude, fuel, pressure and temperature.

To change the units of measure:

1. Press and hold **MSG** and rotate  to display the nav units page.
2. Press **CRSR** twice and rotate  to highlight the field you would like to change.
3. Use  to change the unit of measure.
4. Rotate  to advance to the next field, or press **CRSR** when finished.

The available units of measure are:

position :

- degrees, minutes and seconds (dms) [hddd° mm' ss.s"]
- degrees and minutes (dm) [hddd° mm.mmm']

altitude :

- feet (ft)
- meters (m)

vertical speed :

- feet per minute (fpm)
- meters per minute (mpm)
- meters per second (mps)

nav units :

- nautical miles and knots (nm, kt)
- statute miles and miles per hour (mi, mh)
- kilometers and kilometers per hour (km, kh)

fuel :

- gallons (gl)
- imperial gallons (ig)
- kilograms (kg)
- pounds (lb)
- liters (lt)

pressure :

- inches of mercury (hg)
- millibars (mb)

temperature :

- degrees Fahrenheit (°f)
- degrees Celsius (°c)

The **Special Use Airspace settings page** will allow you to turn the controlled/restricted airspace message alerts on or off. This will not affect the alerts listed on the nearest page. It will simply turn off the warning when you are approaching or near an SUA. Warnings can be turned on/off for the following airspaces:

| | | | |
|----------------------|----------------------------|---------------|---|
| class B/cta : | ICAO control area | moa: | Military operations area |
| class C/tma : | ICAO Terminal Control Area | other: | Other areas includes- alert, caution, danger, training, warning |
| rstcd: | Restricted areas | | |

SUA warnings for prohibited airspace cannot be turned off. The 'alt' field, located at the bottom of the SUA settings page, is an altitude buffer which 'expands' the vertical range of the SUA, so you will be notified if you are within a certain range of an SUA. For example, if the buffer is set at 500 feet, and you are more than 500 feet above or below an SUA, you will not be notified with an alert message; if you are less than 500 feet above or below an SUA and projected to enter it, you will be notified with an alert message. The default setting for the altitude buffer is 200 feet.

To set the warnings or change the altitude buffer:

1. Press and hold **MSG**, and use **○** to display the SUA settings page.
2. Press **CRSR** twice.
3. Rotate **○** to highlight the field you would like to change.
4. Use **○** to change to 'on' or 'off'.
5. To change the altitude buffer, highlight the buffer value, and use **○** and **○** to change the data. Press **ENT** to accept.
6. Press **CRSR** to complete.

```
121.90 118.70
cl B/cta on moa on
cl C/tma on oth on
alt: 100m rstcd on
```

The SUA settings page with all airspace alerts enabled and the altitude buffer set to 100 meters.

```
121.90 118.70
cl B/cta on moa on
cl C/tma on oth off
alt: 500f rstcd on
```

The SUA settings page with 'other' airspaces disabled and the altitude buffer set to 500 feet.

SECTION

7

UNIT SETTINGS

Map Datums

```
121.90 118.70
Map datum
WGS 84
Define user datum?
```

Map datum page showing the default WGS 84 datum. This setting should be used unless your paper chart specifies a different datum.

```
121.90 118.70
dx: 100m dy: -40m
dz: 30m da: 10m
df: -1.00000000e-4 ok?
```

User datum page. To use this function you must enter the parameters as differences from the WGS 84 default.

The NavData card contains over 100 map datums for you to use when navigating. By default, your unit calculates positions using the WGS 84 map datum. If you are using charts based on another datum, you must set the GNC 300XL to use the same datum. Using a map datum that does not match the charts you are using can result in significant differences in position information. If you are using maps for reference only, the GNC 300XL will provide correct navigation guidance to the waypoints contained in the database, regardless of the datum selected.

To change the map datum to one listed in Appendix F:





1. Press and hold **MSG** and use \odot to display the map datum page.
2. Press **CRSR** twice to highlight the current map datum.
3. Use \odot to change the datum.
4. Press **CRSR** to complete.

To create a user datum:

1. Press and hold **MSG** and use \odot to display the map datum page.
2. Press **CRSR** twice.
3. Use \odot to highlight 'Define user datum?'. Press **ENT**.
4. Enter the five parameters of the map datum using \odot and \ominus . Press **ENT** to accept a field. The signs of each value (+/-) should follow the convention: WGS84-local geodetic system.
5. Use \odot to highlight 'ok?', and press **ENT**.
6. To activate the user datum, select 'USER' on the map datum page as described above.

The last page available under the GNC 300XLs setup menu is the **I/O setup page**. The I/O setup page lets you configure the GNC 300XL to input RTCM SC-104 correction data, output to a RS-232 mapping device or a PC (with the optional GARMIN PC Kit or other mapping software) and select the appropriate baud rate. The I/O setup page only provides access to I/O channel 2 input/output. For information on using I/O channel 1, please see your GNC 300XL installation manual.

To change the output settings for I/O channel 2:

1. Press and hold **MSG**, and rotate  until the I/O setup page is displayed.
2. Press **CRSR** twice, and rotate  to select 'off' or 'plotting' for output to an RS-232 device.
3. Rotate  to advance the cursor to the baud rate field.
4. Use  to select the desired baud rate (300,1200, 2400, 4800 or 9600).
5. Press **CRSR** to finish.

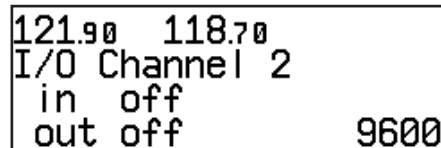

I/O setup page

APPENDIX

A

NAVDATA CARD

Saving User Data

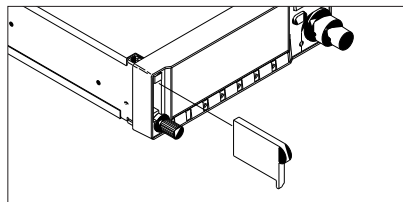

Insert the card with the thumb tab at the top, and the beveled corner on the bottom right.

```
121.90 118.70
No data card present
Reinit in 29 seconds
or ENT to reinit
```

Data card warning

Appendix A

NavData® and User Data Installation/Operation

The NavData card supplied with your GNC 300XL can be installed or removed when the GNC 300XL is on or off. Insert the card with the thumb tab at the top, and the beveled corner at the bottom. If the NavData card is not present when the unit is powered on, you will receive a 'No Jeppesen database' message on the database confirmation page, and you will only be able to use user waypoints for navigation. If the NavData card is removed during operation, a 'No data card present' warning will appear, asking you to reinsert the data card within 30 seconds. If the card is not replaced within 30 seconds, the GNC 300XL will automatically reinitialize. You may also reinitialize the unit manually by pressing **ENT**.



An optional **user data card** can be used to make a backup of user waypoints, routes, etc. and/or transfer information to another GNC 300XL.

To save user data to the user data card:

1. Install the user data card.
2. Rotate  to highlight 'Save user data?'. Press **ENT** to confirm.

The message 'Saving to card' is displayed while the GNC 300XL transfers all user data to the User Data card. It may take a few minutes to complete the transfer. When all user data is transferred, the GNC 300XL will instruct you to turn the unit off, remove the user card and insert the Jeppesen NavData card. After this is complete, the GNC 300XL is ready for normal operation.



To restore user data from a user data card to the GNC 300XL:

1. Install the user data card.
2. Rotate  to highlight 'Restore user data?'.
3. Press .

The GNC 300XL will ask you which type of data to replace. You may choose checklists, scheduler messages, user waypoints, proximity waypoints, routes, waypoint comments, or all data.

4. Rotate  to select the type of data to replace.

You may either replace or update the information in the database. Replacing the data will replace **ALL** user data with the data from the card. Updating the data will not delete unrelated material, but will only change what is necessary to use the data received from the user data card.

5. Rotate  to select either 'Replace?' or 'Update?'.
6. Press  to begin transferring data to the GNC 300XL. The GNC 300XL will now transfer all of the data requested. This may take a few minutes.
7. To continue with more data transfer types, repeat steps 4, 5 and 6. Otherwise, press  when 'ok?' is highlighted.
8. Turn the GNC 300XL off and replace the user data card with a NavData card. The GNC 300XL is now ready for normal operation.

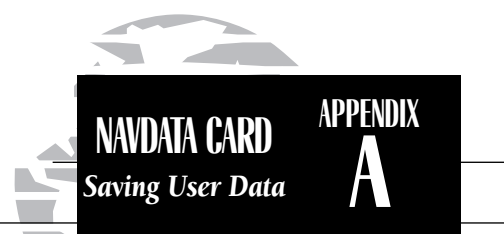
A screenshot of a handheld device screen. At the top, it shows '121.90 118.70'. Below that, the text reads 'User card transfer', 'Restore user data?' (highlighted with a black bar), and 'Save user data?'.

121.90 118.70
User card transfer
Restore user data?
Save user data?

Data transfer page

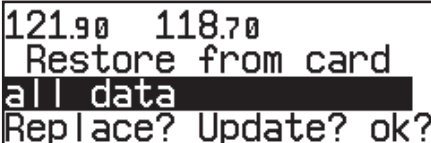
A screenshot of a handheld device screen. At the top, it shows '121.90 118.70'. Below that, the text reads 'Restore from card', 'all data' (highlighted with a black bar), and 'Replace? Update? ok?' (with 'ok?' highlighted).

121.90 118.70
Restore from card
all data
Replace? Update? ok?

Restore data page

APPENDIX B

INSTALLATION & MAINTENANCE

The GNC 300XL is built to exacting standards and does not require user maintenance. If the faceplate and lens require cleaning, use a soft cloth and non-abrasive cleaner.

*The user data is maintained by an internal battery with a projected life of 3 to 5 years. If the GNC 300XL detects a low memory battery, you will be informed with the message 'Memory battery low'. Failure to have the battery replaced may result in loss of data each time you turn your unit off. This will **greatly** increase satellite acquisition time and no user data will be saved. This condition will be accompanied by the message 'Stored data lost'.*

The GNC 300XL contains a crystal oscillator which may drift after many years of operation. If the unit detects excessive oscillator drift, you will be informed with the message 'Osc needs adjustment'. When this occurs, contact an authorized GARMIN service center for service. Failure to do so may result in severely degraded acquisition performance.

Appendix B Installation, Removal and Maintenance of the GNC 300XL

The aviation rack is designed to allow easy removal of the GNC 300XL. This enables you to use the unit at home to create routes, interface to a PC, etc. using an optional AC adapter.

To install the GNC 300XL into the aviation rack:

1. Insert a 3/32" allen wrench in the small hole adjacent to the dual knob.
2. Rotate the wrench counterclockwise until it stops to ensure the pawl latch is in the proper position.
3. Insert the GNC 300XL into the aviation rack and rotate the wrench clockwise to secure the unit. To ensure proper connector seating, gently press on the left side of the unit until tightened.

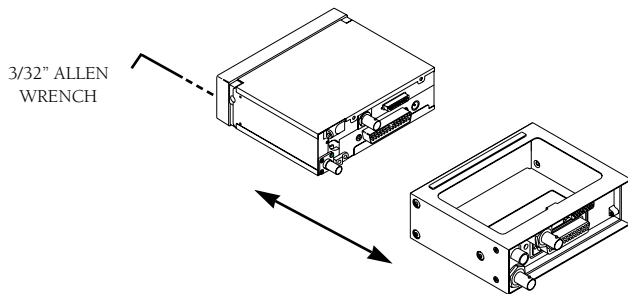





To remove the GNC 300XL from the aviation rack:

1. Insert a 3/32" allen wrench in the small hole adjacent to the dual knob.
2. Rotate the wrench counterclockwise until the GNC 300XL can be removed from the rack.

Appendix C

The GNC 300XL's simulator mode allows you to plan and practice flights in your home and office using an optional remote battery pack or AC adapter. **The simulator is not accessible when the GNC 300XL is running off the master avionics switch.** All waypoint and route planning done in simulator mode will be saved in the unit's internal memory.

To operate the GNC 300XL in simulator mode:

1. Turn the unit on by rotating the  knob clockwise. The welcome page will appear while the unit conducts a self test. Once the self test is complete, the welcome page will be replaced by the operating mode page.
2. Rotate  to move the cursor over the operating mode field ('Normal').
3. Rotate  to select 'Simulator' and press the  key. The cursor will advance to the 'ok?' prompt. Press  to confirm.

Once the GNC 300XL has been placed in simulator mode, the database confirmation page will appear, showing the operating dates, cycle number and database type available.

To acknowledge the database information:

1. Press .

After the database has been acknowledged, the initial position reference page will appear, where you may specify the starting position for your simulated trip. You can define the initial position by entering a waypoint identifier in the reference field, or by manually entering coordinates in the lat/lon field.

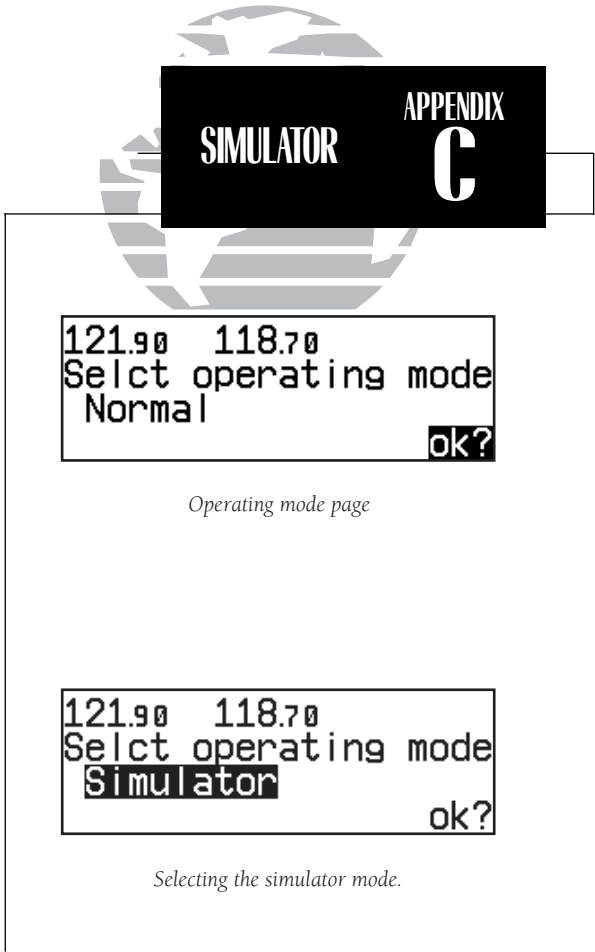

```
121.90 118.70
Selct operating mode
Normal
ok?
```

Operating mode page

```
121.90 118.70
Selct operating mode
Simulator
ok?
```

Selecting the simulator mode.

```

118.30 122.80
WORLDWIDE VFR SUA
eff 27-feb-97 (9703)
exp 27-mar-97 ok?

```

Database confirmation page





```

118.30 122.80
Init posn ref:KIXD.
N38° 58.70' W094° 54.32'
ok?

```









Entering an initial position reference.

To enter an initial position reference by waypoint identifier:

1. Rotate  to highlight the waypoint identifier field.
2. Use  and  to spell out the identifier of the desired airport, navaid or user waypoint.
3. Press  to confirm the identifier. The waypoint confirmation page will appear, displaying the waypoint's position.
4. Press  to confirm the 'ok?' prompt.

The position page will now appear, and you may now use most of the GNC 300XL navigation features for practice and planning. You'll also receive a 'Do not use for nav' message to remind you that the simulator mode should never be used for actual navigation. During simulator operation, you will be able to enter a ground speed from the CDI page, and define a course to a destination from the direct-to confirmation page. Altitude may only be entered by using the VNAV function available from the NAV menu 1 page (see page 26).

To enter a ground speed from the CDI page:

1. Press  and rotate  to display the CDI page.
2. Press  twice to activate the cursor in the GPS window.
3. Rotate  to highlight the ground speed field.
4. Use  and  to enter the desired speed. Press  to accept, and  to finish.

To exit the simulator mode, the GNC 300XL must be turned off by rotating the  knob counterclockwise until the unit shuts down. All waypoints and routes created in simulator mode will be retained in the GNC 300XL's internal memory.

Appendix D

GNC 300XL Messages and Abbreviations

The GNC 300XL uses the message page to communicate important information to you. Some messages are advisory in nature, others are warnings that may require your intervention. This appendix provides a complete list of GNC 300XL messages and their meanings.



- Altitude input fail** - The altitude serializer input is not available for the GNC 300XL. Check the I/O settings and/or the serializer installation. If enough satellites are available for a 3D position fix, no pilot action is required, providing no RAIM warnings are present. If only a 2D fix is possible, the pilot should enter an altitude within 1,000 feet of the current indicated altitude.
- Arrvl at offst _____** - Your craft has entered the arrival alarm circle for the indicated waypoint offset by the parallel track distance.
- Appr switch stuck** - The GPS APR switch is stuck in the 'pressed' position. Check the switch/installation.
- Auto CDI slctd** - The GNC 300XL has reset the CDI scale preference to the 'auto' setting to permit approach navigation.
- Approach deleted** - The selected approach was deleted from the route because not enough room existed to insert a SID or STAR.
- Battery low** - The optional remote battery pack is low on power and limited operating time remains. The battery should be recharged for continued operation.
- Approach not active** - The approach could not transition to the active phase because the GPS SEQ switch is set to the HOLD position, the approach has been manually disarmed using the GPS APR switch, the automatic CDI scale is not selected or offset navigation is in effect. Do not descend at the FAF.
- Battery rqrs service** - A problem has been detected in the optional remote battery pack. The battery should be serviced at an authorized GARMIN service center.
- Arm approach mode** - Approach navigation is available. Press the GPS APR switch to re-arm the approach.
- Cannot chng actv wpt** - An attempt has been made to modify the position of the 'active to' or 'active from' waypoint. The GNC 300XL will not allow the modifications.
- Arrival at _____** - Your craft has entered the arrival alarm circle for the indicated waypoint.
- Cannot chng wpt sqnc-** An attempt has been made to modify an approach, SID or STAR. The waypoint sequence of approaches, SIDs and STARs may not be modified.
- Cannot nav lockd rte** - An attempt has been made to activate a route containing a locked waypoint. The GNC 300XL cannot perform navigation in this situation.

- Cannot ofst goto rte** - An attempt has been made to engage offset navigation feature while the GNC 300XL is navigating using a single waypoint route. The GNC 300XL will not allow offset navigation in this situation.
- Checklist is full** - The selected checklist is full. No new items can be added until existing items are deleted.
- COM failed** - The communications transceiver in the GNC 300XL has failed. Take the unit to an authorized GARMIN service center.
- Comment memory full** - The waypoint comment memory is full. You must delete existing waypoint comments before adding new ones.
- Configuration reset** - The GNC 300XL has detected a failure in its installation configuration memory. Data from the user memory has been used to reset the configuration. Check the installation settings for correctness. If the message persists, the unit is not usable and should be taken to an authorized service center for repair.
- Course input fail** - The course input from RS-422 or ARINC 429 is not available to the GNC 300XL. Check the I/O settings and/or have the installation checked by a certified technician.
- Data card failed** - The GNC 300XL has detected a problem with the data card. The data is not usable and the card should be returned to Jeppesen or an authorized GARMIN service center.
- Data card write fail** - The user data card failed to program. The card should be returned to an authorized GARMIN service center.
- Degraded accuracy** - The GNC 300XL has detected poor satellite geometry while RAIM is not available. Additional cross-checking with a secondary navigation source should be performed to verify the integrity of the GPS position.
- Do not use for nav** - The GNC 300XL is in the simulator mode and must not be used for actual navigation.
- EEPROM write fail** - The GNC 300XL has detected a failure while programming its installation configuration memory. The unit is not usable and should be taken to an authorized service center.
- Final altitude alert** - The suggested altitude is within 1000 feet of the final altitude entered on the VNAV planning page.
- Fuel/Air input fail** - The fuel and/or air data input is not available to the GNC 300XL. Check the I/O settings and the fuel/air system installation.
- Heading input fail** - The heading input from ARINC 429 is not available to the GNC 300XL. Check the I/O settings and/or have the installation checked by a certified technician.
- Inside SUA** - You have entered a Special Use Airspace.



- Invalid CPA wpt _____** - The closest point of approach cannot be created from the waypoint entered on the CPA Page. This occurs when the computed point does not fall on one of the route legs, or when a unique waypoint name for the closest point of approach cannot be found.
- Invalid copy route** - A non-empty route was selected for a copy operation. A route must be empty before another route can be copied to it.
- Invalid CPA route** - The selected route contains less than two waypoints and cannot be used for CPA operations.
- Invalid SAR route** - The selected route does not contain exactly two waypoints and cannot be used for SAR operations.
- Leg not smoothed** - The upcoming leg is too short for smooth waypoint transitions. Expect a rapid change in the CDI.
- Memory battery low** - The battery that sustains user memory is low and should be replaced by an authorized GARMIN service center as soon as possible. Failure to do so may result in loss of stored data, including all user waypoints and routes.
- Near SUA < 2 nm** - Your position is within 2 nm of an SUA, and your current course will **not** take you inside.
- Need alt - press NAV** - The GNC 300XL needs altitude input in order to start and/or continue 2D navigation. Press the NAV key and enter your antenna altitude on the position page. The altitude you enter should be as accurate as possible. An inaccurate altitude will directly translate into inaccurate position information.

No altitude input

- The GNC 300XL has failed to receive altitude data from the parallel input. Check the I/O settings and/or the installation. If enough satellites are available for a 3D position fix, no pilot action is required, providing no RAIM warnings are present. If only a 2D fix is possible, the pilot should maintain the GPS altitude within 1,000 feet of pressure altitude, using the position page.

No course input

- The GPS SEQ switch is set to the HOLD position and has no selected course input from the CDI/HSI. Check the state of configuration switches if installed, or check the CDI/HSI unit.

No DGPS position

- Not enough data is available to compute a differential GPS (DGPS) position.

No RAIM FAF to MAP

- RAIM is predicted to NOT be available from the final approach fix to the missed approach point. The approach is no longer active.

No RTCM input

- DGPS data, in an RTCM SC-104 format, is not available.

- Offset nav cancelled** - Offset navigation has been cancelled due to a direct-to operation or modification of the active route.
- Offset nav in effect** - Offset navigation mode is in effect.
- Ofst too big for rte** - The parallel track distance is too large for the active route.
- Osc needs adjustment** - The GNC 300XL has detected excessive drift in its internal crystal oscillator which may result in longer acquisition time. The unit should be taken to an authorized GARMIN service center immediately.
- Poor GPS coverage** - The GNC 300XL cannot acquire sufficient satellites necessary to provide navigation.
- Prox alarm-press NAV** - Your craft has penetrated the alarm circle of a proximity waypoint. Press NAV to see the bearing and distance to the proximity waypoint.
- Proximity overlap** - The circles defined by two proximity waypoints overlap. When entering the area of the overlap, the GNC 300XL will warn you of the closest proximity waypoint, but not both. You should be certain this condition is desirable.
- Proximity wpt locked** - At least one proximity waypoint is locked because the waypoint has been removed from the Jeppesen NavData®, the data card is missing, or the data card has failed.
- Proximity wpt moved** - One or more proximity waypoints were moved at least 0.33 arc minutes due to a database change.
- Proximity wpt deleted** - One or more proximity waypoints were deleted while receiving data from the PC Interface Kit.
- Pwr down and re-init** - The GNC 300XL is unusable until power has been cycled and the unit re-initialized. Abnormal satellite conditions may exist.
- RAIM not available** - RAIM is unavailable for the phase of flight you are currently in (the HSI NAV flag should also appear). Revert to alternate navigation.
- RAIM position warn** - RAIM has detected position errors exceeding those allowed for a given phase of flight. Revert to an alternate source of navigation. If the warning occurs during the final approach segment (FAF to MAP), execute the published missed approach.
- RAM failed** - The GNC 300XL has detected a failure in its internal memory. If the message persists, the GNC 300XL is unusable and should be taken to an authorized GARMIN service center.
- Rcvr needs service** - The GNC 300XL has detected a condition requiring service in the receiver hardware. The GNC 300XL should be taken to an authorized GARMIN service center.
- Ready for navigation** - The GNC 300XL is ready for navigation.
- Receiver failed** - The GNC 300XL has detected a failure in the receiver hardware. If the message persists, the GNC 300XL is unusable and should be taken to an authorized GARMIN service center.



- | | | | |
|-----------------------------|--|------------------------------|---|
| Remote ENT key stuck | - The remote ENT key is stuck in the 'pressed' state. Check the installation. | | |
| Remote XFR key stuck | - The remote XFR key is stuck in the 'pressed' state. Check the installation. | | |
| ROM failed | - The GNC 300XL has detected a failure in its permanent memory. If this message occurs, the unit is unusable and should be taken to an authorized GARMIN service center. | | |
| Route is empty | - An attempt has been made to activate an empty route. | | |
| Route is full | - An attempt has been made to add more than 31 waypoints to a route. The GNC 300XL will not allow more than 31 waypoints per route. | Set course to ____° | - The CDI/HSI should be set to the specified course. |
| Route truncated | - The route was truncated because not enough room existed to insert a SID, STAR or approach. | SID deleted | - The SID was deleted from the route because of insufficient space in the route. |
| Route wpt deleted | - One or more route waypoints were deleted while receiving data from the optional PC Interface Kit. | STAR deleted | - The STAR was deleted from the route because of insufficient space in the route. |
| Route wpt locked | - At least one route waypoint is locked because the waypoint has been removed from the Jeppesen NavData®, the data card is missing, or the data card has failed. | Start altitude chng | - The altitude change entered on the VNAV Planning page is about to begin. |
| Route wpt moved | - One or more route waypoints were moved at least 0.33 arc minutes due to a database change. | Steep turn ahead | - This message appears approximately 90 seconds prior to a turn that requires a bank angle in excess of 25 degrees in order to stay on course. Turn anticipation will not be provided for the turn. |
| RTCM input fail | - The DGPS data signal was being received but has now been lost. Check wiring. | Stored data lost | - Stored user data, including waypoints, routes and satellite orbital data have been lost due to a low memory battery or inadvertent master reset. |
| Searching the sky | - The GNC 300XL is in the search-the-sky mode. Allow the unit to complete data collection before turning it off. | Stuck mic/tx disabled | - The microphone/headsets have been transmitting continuously for 35 seconds, and the transmitter has been disabled. Releasing the transmit key will allow you to transmit again. If this message persists, check the installation. |
| Select auto seq mode | - The GPS SEQ switch should be set to the 'Auto' position to continue navigation. | | |

- SUA ahead < 10 min** - The projected course and current speed will take you inside an SUA within the next 10 minutes.
- SUA near & ahead** - Your position is within two nautical miles of an SUA and your current course will take you inside.
- Timer expired** - The approach timer has expired.
- User data RX started** - Data receive operations have started.
- Usr data TX complete** - Data transmit operations are complete.
- VNAV cancelled** - The VNAV function has been cancelled due to a change in the active route.
- WGS 84 datum selectd** - The system map datum was changed to WGS 84 because the selected map datum has been removed from the NavData card, the data card is missing, or the data card has failed.
- Wpt comment locked** - At least one waypoint comment is locked because the waypoint has been removed from the Jeppesen NavData®, the data card is missing, or the data card has failed.
- Wpt exists _____** - You have entered a waypoint name on the AutoStore™ Page or user waypoint catalog page that already exists in memory. Enter a

Wpt memory full

- waypoint name that does not exist.
- The waypoint memory is full. You should delete unused waypoints to make room for new waypoints.

This section of Appendix D provides a complete list of GNC 300XL abbreviations and their meanings.

| | | | |
|---------------|---|---------------|------------------------------|
| ALT- | Altitude | DEG- | Degrees |
| APP- | Approach | DEP- | Departure |
| APR- | Approach | DIS- | Distance To Waypoint |
| APT- | Airport Waypoint | DME - | Distance Measuring Equipment |
| ARTCC- | Air Route Traffic Control Center | DOP- | Dilution of Precision |
| ARV- | Arrival | DTK- | Desired Track |
| ATF- | Aerodrome Traffic Frequency | ELEV- | Elevation |
| ATS- | Automatic Terminal Information Service (ATIS) | ENDUR- | Endurance |
| AVGS- | Aviation Gas | EPE- | Estimated Position Error |
| AZM- | Azimuth (bearing) | ESA- | En route Safe Altitude |
| BRG- | Bearing | ETA- | Estimated Time of Arrival |
| CAS- | Calibrated Airspeed | ETE- | Estimated Time En route |
| CDI- | Course Deviation Indicator | FIR- | Flight Information Region |
| CL B- | Class B | FLOW- | Fuel Flow Rate |
| CL C- | Class C | FOB- | Fuel On Board |
| CLR- | Clearance Delivery | FPM- | Feet Per Minute |
| CPA- | Closest Point of Approach | FR- | From |
| CTA- | ICAO Control Area | FSS- | Flight Service Station |
| CTAF- | Common Traffic Advisory Frequency | FT- | Feet |
| CTF- | Common Traffic Advisory Frequency | FT- | Full Time |
| CTR- | Center (ARTCC) | GL- | Gallons |
| CTS- | Course To Steer | GND- | Ground |
| CUM- | Cumulative | GPS- | Global Positioning System |
| DALT- | Density Altitude | GS- | Ground Speed |
| | | HDG- | Heading |
| | | HG- | Inches of Mercury |
| | | IALT- | Indicated Altitude |



| | | | |
|-----------------|---------------------------|---------------|--|
| ILS- | Instrument Landing System | MSA- | Minimum Safe Altitude |
| IG- | Imperial Gallons | MT- | Meters |
| INT- | Intersection Waypoint | MUL- | Multicom |
| JET A- | Jet Fuel - Type A | NDB- | NDB Waypoint |
| JET B- | Jet Fuel - Type B | NM- | Nautical Miles |
| KH- | Kilometers Per Hour | NP- | Non-Precision |
| KM- | Kilometers | NR- | Nearest |
| KT- | Knots | OBS- | Omni-directional Bearing Select (Inbound Course Select) |
| LB- | Pounds | OTH- | Other |
| LCL- | Local | °C- | Degrees Celsius |
| LEN- | Length | °F- | Degrees Fahrenheit |
| LFLOW- | Left Fuel Flow | PC- | Pilot Controlled |
| LFOB- | Leftover Fuel On Board | POSN- | Position |
| LOC- | Localizer | PRES- | Barometric Pressure (Altimeter Setting) |
| LT- | Liters | PROX- | Proximity |
| MAG VAR- | Magnetic Variation | PRX- | Proximity |
| MB- | Millibars Of Pressure | PT- | Part Time |
| MF- | Mandatory Frequency | PTX- | Pre-Taxi |
| MH- | Statute Miles Per Hour | PWR- | Power |
| MI- | Statute Miles | RDR- | Radar |
| MIC- | Microphone | REQ- | Required |
| MIN- | Minimum | RF- | Reference |
| MIN - | Minutes | RFLOW- | Right Fuel Flow |
| MOA- | Military Operations Area | RNG- | Range |
| MPM- | Meters Per Minute | | |
| MPS- | Meters Per Second | | |

RNWX- Runway
RSTCD- Restricted
RSV- Reserves
RTE- Route
RX- Receive Only
SAR- Search And Rescue
SEC- Seconds
SEQ- Sequence
SGL- Signal
SID- Standard Instrument
Departure
SLCT- Select
SRFC- Surface
STAR- Standard Terminal Arrival
Route
STR- Steer To
TACAN- TACTical Air Navigational Aid
TAS- True Airspeed
TAT - Total Air Temperature
TEMP- Temperature
TMA- ICAO Terminal Control Area
TRK- Track Angle
TRN- Turn Angle
TRSA- Terminal Radar Service Area
TWR- Tower
TX- Transmit Only
U- UTC Time

UNI- Unicorn
URA- User Range Accuracy
USER- User Waypoint
USR- User Waypoint
UTC- Universal Time Coordinated
(GMT/ Zulu)
VN- VNAV or Vertical Navigation
VNAV- Vertical Navigation
VOR- VOR Waypoint
WPT- Waypoint
WX- Weather
XFR- Transfer



APPENDIX

E

SPECIFICATIONS

*** Subject to accuracy degradation to 100m 2DRMS under the US DOD-imposed Selective Availability Program.*

```
121.90 118.70
Turning off 29 scnds
Press any key to
continue navigation
```

Whenever the GNC 300XL is connected to the optional remote battery pack and power from the master switch is lost, the unit will revert to battery power. To continue navigation, press any key when the power down page appears.

Appendix E Specifications

PHYSICAL

| | |
|--------------|--|
| Size: | 6.25"W x 5.8"D x 2"H (159mm x 147mm x 51mm) |
| Weight: | 39 ounces (1.11kg) |
| Rack Size: | 6.32"W x 5.64"D x 2"H (161mm x 143mm x 51mm) |
| Rack Weight: | 11 ounces (0.31kg) |

POWER

| | |
|--------|--|
| Input: | 10-15V DC with power cable (aircraft power) Optional remote battery pack 115V or 230V AC w/ optional adapter |
|--------|--|

ENVIRONMENTAL

| | |
|--------------|---|
| Temperature: | -4° F to 158° F (-20°C to 70°C) Operating -67°F to 185°F (-55°C to 85°C) Storage |
|--------------|---|

PERFORMANCE

| | |
|-------------------|---|
| Comm: | 760 channel, aviation band 118-136.975 MHz 5-watt minimum transmit power |
| Receiver: | 12 channel PhaseTrac12™ |
| Acquisition Time: | 45 seconds (typical) 15 seconds (warm start, with ephemeris) |
| Update Rate: | 1 per second, continuously |
| Accuracy: | 15 meters (49ft.) RMS** |
| Dynamics: | 999 knots velocity, 3g acceleration |

INTERFACES

ARINC 429, Plotting (NMEA 0183 V2.0), Aviation, PC Interface, Altitude Serializer, Fuel Sensor, Fuel/Air Data Computer

Appendix F

Map Datums



| | | | |
|-----------------------------|---|------------------------------|--|
| ADINDAN | Ethiopia, Mali, Senegal, Sudan | DOS 1968 | Gizo Island (New Georgia Islands) |
| AFGOOYE | Somalia | EASTER ISLAND 1967 | Easter Island |
| AIN EL ABD 1970 | Bahrain Island, Saudi Arabia | EUROPEAN 1950 | Austria, Belgium, Denmark, Finland, France, Germany, Gibraltar, Greece, Italy, Luxembourg, Netherlands, Norway, Portugal, Spain, Sweden, Switzerland |
| ANNA 1 ASTRO 1965 | Cocos Islands | EUROPEAN 1979 | Austria, Finland, Netherlands, Norway, Spain, Sweden, Switzerland |
| ARC 1950 | Botswana, Lesotho, Malawi, Swaziland, Zaire, Zambia, Zimbabwe | FINLAND HAYFORD 1910 | Finland |
| ARC 1960 | Kenya, Tanzania | G. SEGARA | Borneo |
| ASCENSION IS 1958 | Ascension Island | GANDAJIKA BASE | Republic of Maldives |
| ASTRO B4 SOROL ATOLL | Tern Island | GEODETIC DATUM 1949 | New Zealand |
| ASTRO BEACON "E" | Iwo Jima Island | GGRS 87 | Greece |
| ASTRO DOS 71/4 | St. Helena Island | GUAM 1963 | Guam Island |
| ASTRONOMIC STN 1952 | Marcus Island | GUX 1 ASTRO | Guadalcanal Island |
| AUSTRALIAN GEOD 1966 | Australia, Tasmania Island | HERAT NORTH | Afghanistan |
| AUSTRALIAN GEOD 1984 | Australia, Tasmania Island | HJORSEY 1955 | Iceland |
| AUSTRIA NS | Austria | HONG KONG 1963 | Hong Kong |
| BELGIUM 1950 | Belgium | HU-TZU-SHAN | Taiwan |
| BELLEVUE (IGN) | Efate and Erromango Islands | INDIAN BNGLD5H NEPAL | Bangladesh, India, Nepal |
| BERMUDA 1957 | Bermuda Islands | INDIAN MEAN VALUE | India |
| BOGOTA OBSERVATORY | Colombia | INDIAN THAILAND VIETN | Thailand, Vietnam |
| BUKIT RIMPAH | Indonesia | INDONESIA 74 | Indonesia |
| CAMP AREA ASTRO | Antarctica | IRELAND 1965 | Ireland |
| CAMPO INCHAUSPE | Argentina | ISTS 073 ASTRO 1969 | Diego Garcia |
| CANTON ASTRO 1966 | Phoenix Islands | JOHNSTON ISLAND 1961 | Johnston Island |
| CAPE | South Africa | KANDAWALA | Sri Lanka |
| CAPE CANAVERAL | Florida, Bahama Islands | KERGUELEN ISLAND | Kerguelen Island |
| CARTHAGE | Tunisia | KERTAUI 1948 | West Malaysia, Singapore |
| CH-1903 | Switzerland | L.C. 5 ASTRO | Cayman Brac Island |
| CHATHAM 1971 | Chatham Island (New Zealand) | LIBERIA 1964 | Liberia |
| CHUA ASTRO | Paraguay | LUZON MEAN VALUE | Philippines |
| CORREGO ALEGRE | Brazil | LUZON MINDANAO IS | Mindanao Island |
| DANISH GI 1934 | Denmark | | |
| DJAKARTA (BATAVIA) | Sumatra Island (Indonesia) | | |

LUZON PHILIPPINESPhilippines
(excluding Mindanao Isl.)**MAHE 1971**

Mahe Island

MARCO ASTRO

Salvage Islands

MASSAWA

Eritrea (Ethiopia)

MERCHICH

Morocco

MIDWAY ASTRO 1961

Midway Island

MINNA

Nigeria

NAD27 ALASKA

North American 1927- Alaska

NAD27 BAHAMASBahamas (excluding San
Salvador Island)**NAD27 CANADA**Canada (including
Newfoundland Island)**NAD27 CANAL ZONE**

Canal Zone

NAD27 CARIBBEANCaribbean (Barbados,
Caicos Islands, Cuba,
Dom. Rep., Grd. Cayman,
Jamaica, Leeward and
Turks Islands)**NAD27 CENTRL AMERICA**Central America (Belize,
Costa Rica, El Salvador,
Guatemala, Honduras,
Nicaragua)**NAD27 CONUS**

Mean Value (CONUS)

NAD27 CUBA

Cuba

NAD27 GREENLAND

Greenland (Hayes Peninsula)

NAD27 MEXICO

Mexico

NAD27 SAN SALVADR IS

San Salvador Island

NAD83North American 1983-
Alaska, Canada, Central
America, CONUS, Mexico**NAHRWAN MASIRAH IS**

Masirah Island (Oman)

NAHRWAN SAUDI ARABIA

Saudi Arabia

NAHRWAN UNITD ARAB E

United Arab Emirates

NAPARIMA BWI

Trinidad and Tobago

NETHERLAND TRIAG '21

Netherlands

NOU TRIAG FRANCE

France

NOU TRIAG LUXEMBOURG

Luxembourg

OBSERVATORIO 1966Corvo and Flores Islands
(Azores)**OLD EGYPTIAN**

Egypt

OLD HAWAIIAN KAUAI

Kauai

OLD HAWAIIAN MAUI

Maui

OLD HAWAIIAN MEAN

Mean Value

OLD HAWAIIAN OAHU

Oahu

OMAN

Oman

ORD SRV GRT BRITAINEngland, Isle of Man,
Scotland, Shetland Islands,
Wales**PICO DE LAS NIEVES**

Canary Islands

PITCAIRN ASTRO 1967

Pitcairn Island

PORTUGUESE 1973

Portugal

POTSDAM

Germany

PROV SO AMERICAN '56Bolivia, Chile, Colombia,
Ecuador, Guyana, Peru,
Venezuela**PROV SO CHILEAN 1963**

South Chile

PUERTO RICO

Puerto Rico & Virgin Isl.

QATAR NATIONAL

Qatar

QORNOQ

South Greenland

REUNION

Mascarene Island

ROME 1940

Sardinia Island

RT 90

Sweden

SANTO (DOS)

Espirito Santo Island

SAO BRAZSao Miguel, Santa Maria
Islands (Azores)**SAPPER HILL 1943**

East Falkland Island

SCHWARZECK

Namibia

SOUTH AMERICAN 1969Argentina, Bolivia, Brazil,
Chile, Colombia, Ecuador,
Guyana, Paraguay, Peru,
Venezuela, Trinidad/Tobago**SOUTH ASIA**

Singapore

SOUTHEAST BASEPorto Santo and Madeira
Islands**SOUTHWEST BASE**Faial, Graciosa, Pico, Sao
Jorge and Terceira Islands
(Azores)**TANANARIVE OBSV 1925**

Madagascar

TIMBALAI 1948Brunei and East Malaysia
(Sarawak and Sabah)**TOKYO**

Japan, Korea, Okinawa

TRISTAN ASTRO 1968

Tristan da Cunha

USER

User datum

VITI LEVU 1916

Viti Levu Island/Fiji Islands

WAKE-ENIWETOK 1960

Marshall Islands

WGS 72

World Geodetic System 1972

WGS 84

World Geodetic System 1984

YACARE

Uruguay

ZANDERIJ

Surinam

Appendix G Troubleshooting Q & A

The GNC 300XL is a precision navigation instrument that offers a wide array of performance navigation features. The 'Q & A' section is designed to answer some of the common questions regarding the GNC 300XL's capabilities and operation. If you have a problem operating your unit, go through the troubleshooting section and refer to the reference section noted. If your problem is not listed in the Q & A section, use the index to find the appropriate reference in the manual. If you still encounter a problem, please see your authorized dealer or call or fax our customer support staff at 913-397-8200 or 913-397-8282 FAX. GARMIN is dedicated to supporting its products and customers.

What is RAIM, and how does it affect approach operations?

RAIM is an acronym for Receiver Autonomous Integrity Monitoring, a receiver function that performs a consistency check on all tracked satellites. RAIM ensures that the available satellite geometry will allow the receiver to calculate a position within a specified protection limit (2 nm for oceanic and en route, 1 nm for terminal and 0.3 nm for non-precision approaches).

During oceanic, en route and terminal phases of flight, RAIM will be nearly 100%. Because of the tighter protection limit on approaches, there may be times when RAIM is not available. The GNC 300XL automatically monitors RAIM and will warn you with an alert message (see Appendix D) when it is not available. If RAIM is not available when crossing the FAF, the ACTV annunciator will not illuminate and the pilot must fly the missed approach procedure. The GNC 300XL's RAIM prediction function (see page 30) will also allow you to see whether RAIM will be available for a specified date and time. NOTE: If RAIM is not predicted to be available for the final approach course, the approach will not become active, as indicated by the ACTV annunciator.



Why aren't there any approaches available for my route?

Approaches are only available when the final route waypoint or direct-to destination is an airport (some VOR/VORTAC identifiers are similar to airport identifiers). If a destination airport does not have a GPS approach, the GNC 300XL will display a 'no procedures in database' message. For more on selecting an approach, see page 89.

What happens when I select an approach? Can I store a route with an approach, SID or STAR?

Whenever you load an approach or STAR into the active route, the arrival airport is moved, and a set of approach or arrival waypoints is inserted. If a SID is loaded into the active route, the SID waypoints will be inserted following the departure airport in the active route. Note: these modifications only apply to the active route, and will not affect the corresponding stored route (if you have activated one). Routes can be stored with an approach, SID or STAR. Keep in mind that the active route is erased when the unit is turned off and overwritten when another route is activated.

When storing routes with an approach, SID or STAR, the GPS will use the waypoint information from the current database to define the waypoints. If the database is changed or updated, the GNC 300XL will automatically update the information if the procedure name has not changed. If an approach, SID or STAR procedure is no longer available, the route will become locked until the procedure is deleted from the route or the correct database is installed. For information on loading an approach, SID or STAR, see pages 78-99. See page 69 for instructions on saving and copying routes.

Can I file slant Romeo '/R' using my GPS?

Yes, you may file your flight plan as /R if your GNC 300XL is a certified A1 or A2 installation. If you are flying en route, you may fly /R with an expired database **only** after you have verified all route waypoints. Non-precision approaches **may not** be flown with an expired database. See your approved Airplane Flight Manual Supplement for more information.



What does the GPS APR switch do? What is ‘arming’ an approach?

The GPS APR switch must be set to the ARM position for an approach to enter the active phase. It may be left in the ARM position to simplify approach operation. Its main function is to provide the pilot with a quick method of deactivating the approach and returning the CDI scale to the 1 nm scale in the event of a missed approach. For more on the GPS APR switch and arming approaches, see pages 78-79.

What does the GPS SEQ switch do and when do I use it?

The GPS SEQ switch is used to select manual or automatic waypoint sequencing of waypoints. Setting the GPS SEQ switch to the HOLD position holds your current ‘active to’ waypoint as your navigation reference and prevents the GPS from sequencing to the next waypoint. When the GPS SEQ switch is set to the AUTO position, automatic waypoint sequencing is selected, and the GPS will automatically select the next waypoint in the route once the aircraft has crossed the present active-to waypoint.

AUTO

Automatic sequencing of waypoints
Change in HSI does not affect CDI deflection
Always navigates ‘TO’ the active waypoint
Must be set to AUTO for approach to go active

HOLD

Manual sequencing- ‘HOLDS’ on selected waypoint
Manually select course to next waypoint from HSI
Will indicate ‘TO’ or ‘FROM’ waypoint
Approach will not go active

The GPS SEQ switch must be set to the HOLD position any time you are deviating from the flight sequence of an approach (e.g., when you are flying radar vectors) or when you must cross the same waypoint twice in succession (e.g., a procedure turn or holding pattern). Whenever the GPS SEQ switch is set to the HOLD position, the GNC 300XL allows you to select the desired course to/from a waypoint using the HSI, much like a VOR, and display a to/from flag for the active-to waypoint. In the AUTO position, the CDI will always display a ‘TO’ indication for the next waypoint once you’ve crossed the active waypoint. Refer to page 92 for an approach example using a HOLD.

When should I switch from HOLD to AUTO, and what happens when I do?

Once you are ready to resume automatic waypoint sequencing, you must set the desired course on your HSI two seconds before changing the GPS SEQ switch to the AUTO position. This allows the the desired course to 'settle' prior to the GNC 300XL using it. Once the GPS SEQ switch is set back to the AUTO position, the GNC 300XL will use the HSI course until you have crossed the active-to waypoint and sequenced to the next route waypoint. See page 80 for more information on the GPS SEQ switch.

Why won't my unit automatically sequence to the next waypoint?

The GNC 300XL will only sequence approach, SID or STAR waypoints when the GPS SEQ switch is in the AUTO position. For automatic sequencing to occur, you must also cross the bisector of the turn you are navigating.

How do I skip a waypoint in an approach, SID or STAR?

The GNC 300XL allows you to manually select any approach, STAR or SID waypoint as your next 'active to' destination. This procedure, called an on-route direct-to, is performed from the active route page by highlighting the desired waypoint and pressing **→**, then **ENT** to approve the selection. The GPS will then provide navigation directly to the selected waypoint, so be sure you have clearance directly to that position. See pages 63 & 76 for more information.

How do I fly the GPS with an autopilot and DG heading bug?

If you do not have an HSI, you should make your course selections on the OBS and the DG heading bug.

When does turn anticipation begin, and what bank angle is expected?

The GNC 300XL will smooth adjacent leg transitions based upon a nominal 15° bank angle (with the ability to roll up to 25°) and provide three pilot cues for turn anticipation: 1) The waypoint annunciator will flash 15 seconds before the turn point and glow steadily 2 seconds prior to the turn anticipation point. Begin the turn when the annunciator goes steady. 2) A flashing 'next dtk' prompt will appear on the GNC 300XL's CDI field. Set the HSI to the next dtk value when the waypoint annunciator starts flashing. 3) The To/From indicator on the GPS CDI will flip momentarily to indicate that you have crossed the midpoint of the turn. For more information on turn anticipation, see page 77.

When does the CDI scale change, and what does it change to?

Whenever an approach is selected and armed, the GNC 300XL will begin a smooth CDI scale transition from the 5.0 nm to the 0.3 nm scale 30 nm from the destination airport (see left). The CDI scale will remain at the 0.3 nm scale from the FAF to the MAP during the active approach. If you are in a missed approach situation, and would like to return the CDI to the 1 nm scale, you may deactivate the approach by releasing the GPS APR switch from the ARM position.

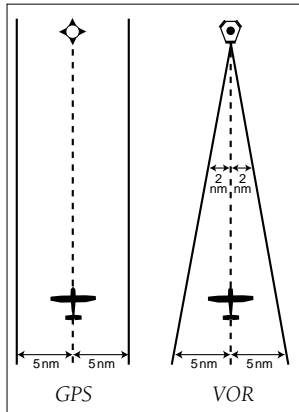

Why does my CDI not respond like a VOR when the GPS SEQ switch is set to HOLD?

Unlike a VOR, the CDI scale used on GPS equipment is based on the cross-track distance to the desired course, not an angular relationship to the destination. Therefore, the CDI deflection on the GPS will be consistent regardless of the distance to the destination, and will not become less sensitive when you are further away from the destination. For more information on the CDI scale, see page 103.

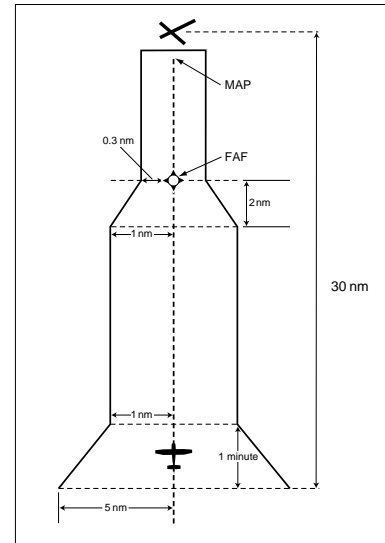

CDI Scale Transition

What is the correct missed approach procedure? How do I select the missed approach holding point?

To comply with TSO specifications, the GNC 300XL will not automatically sequence to the missed approach holding point. The first waypoint in the missed approach procedure will be displayed as the next approach waypoint when the pilot performs a direct-to AFTER crossing the MAP, which the pilot may activate when authorized. All published missed approach procedures must be flown before activating navigation to the holding point. To begin the missed approach procedure prior to the MAP, the GPS APR switch must be released from the 'ARM' position to disarm the approach and begin transition of the CDI to the 1.0 nm scale.

To activate navigation to the first missed approach waypoint after crossing the MAP, press **→**, then **ENT**. The GNC 300XL will provide direct navigation to the holding point. If you do not have direct clearance to the holding point, set the GPS SEQ switch to the HOLD position until you have intercepted the inbound course to the holding point. See page 87 for more information on missed approaches.

How do I re-select the same approach or activate a new approach after a missed approach?

After flying all missed approach procedures, you may reactivate the same approach for another attempt from the active route page. Once you have been given clearance for another attempt, select the starting waypoint from the active route list by highlighting the waypoint identifier and pressing **→**, followed by **ENT**. The GNC 300XL will provide direct navigation to the selected waypoint and rejoin the approach in sequence from that point on. If you have disarmed the previous approach, remember to set the GPS APR switch to the 'ARM' position.

To activate a new approach, you must select the new procedure from the approach select page. To view the approach select page, press **RTE** and rotate **○** until the approach select page appears. Press **CRSR** and rotate **○** to highlight the new approach you want to fly. To activate the new approach, press **ENT** and select the IAF, if necessary. See page 88 for more information on reactivating an approach.

Appendix H

Index

| | | | |
|---|----------------|--|----------------|
| A | | C | |
| Abbreviations | 123-125 | Cautions | ii |
| Accessory list | iii | CDI | 5-6, 12, 103 |
| Activating a route | 68 | CDI page. | 5-6, 11-14 |
| Activating a route in reverse | 68 | CDI sensitivity setting | 12, 103 |
| Active frequency | 3, 33 | Channel 2 I/O | 111 |
| Active to & from waypoints | 62, 74 | Checking GPS coverage | 20-22, 30 |
| Active route page. | 74 | Checklists | 27-28 |
| Adding waypoints to a route | 67, 75 | Clear key | viii |
| Airport comments page. | 37-40, 54 | Clock function | 29 |
| Airport communications page | 39-40, 43 | Closest point of approach (CPA). | 69 |
| Airport runway page | 40, 44 | Communication frequencies | 3, 6, 17, 43 |
| Airport position page | 40-41 | Communications pages | 43 |
| Airport identification page | 39-40 | Communications window | 3 |
| Airport information | 39 | Contrast | 106 |
| Altitude | 17 | Controlled airspace | 41, 58-61, 109 |
| Altitude buffer | 109 | Course select | 14, 64 |
| Approach procedures | 40-42 | Copying routes | 69 |
| Approach select page | 65, 85, 89 | Creating user waypoints | 48-51 |
| Approach timer | 28 | Cursor key | viii, 3 |
| Approaches | 78-95, 130-134 | | |
| Arrival alarm setting | 104 | D | |
| Automatic squelch | 35 | Database | 1, 36-37 |
| Automatic zoom | 101 | Data fields | 7, 12-14 |
| AutoStore™ | 51 | Date & time | 29 |
| Auto-tune | 34 | Deleting user waypoints | 53 |
| | | Deleting routes | 67 |
| B | | Deleting waypoints from routes | 67, 76 |
| Backlighting. | 105, 107 | Density altitude. | 24 |
| Battery saver | 105 | Direct-to cancelling | 63 |



- Direct-to key vii, 5, 63
 Direct-to navigation 5, 62-64
 Display contrast 106
 Display mode 106
 Displaying airports 102
 Displaying identifiers 102
 Displaying airspace boundaries 103
 DOP 20-21
 Downloading data to another 300XL . . . 112
 Duplicate waypoints 55
- E**
 Editing routes 67, 75
 Editing user waypoints 48-50, 53
 Emergency channel select 35
 ENT key viii
 Entering waypoints 38, 48-50
 EPE 20-21
 Emergency channel select 36
 ETE (estimated time en route) 16
- F**
 Foreword i
 Frequency field 33
 Frequency restrictions 17, 43
 Fuel planning 24-25
- G**
 Going to a nearest airport 57
 GPS APR switch 79
 GPS planning 31
 GPS SEQ switch 80
 Ground speed 6, 16
 Ground track (TRK) 16
- H**
 'Hold' on a waypoint 76, 80
- I**
 Inner knob viii
 Installation of the GNC 300XL 114
 Intersections 37, 47
 I/O Outputs 111, 126
- K**
 Key functions vii, viii
 Knob functions vii, viii
- L**
 Locked waypoints 56
- M**
 Magnetic variation 104
 Map datums 110, 127-128
 Map display 6-7, 15
 Map orientation 16, 101
 Map page 6-8, 11, 15-16
 Map scales 8, 16
 Map setup 101, 103
 Measurement units 108
 Messages 2, 28, 31, 56, 58, 117-122
 Missed approaches 82, 84, 87-88, 134
 MSG key viii, 100
- N**
 NAV/GPS switch 79
 NAV Key vii, 4, 11
 NAV menu 1 4, 11, 23-28



NAV menu 2 4, 11, 28-32
NAVCOM page 4, 8, 11, 17-18
NavData cards 36, 112-113
Navigation terms 13
NDBs 37, 46
NRST key vii, 9, 57
Nearest airport 9, 57, 104
Nearest SUA 58-61
Nearest waypoints 9, 57

O

Offset navigation 70
Orientation 16
Outer knob viii

P

Packing list iii
Parallel track 66, 70
Position page 4, 11, 18-19
Power/volume knob vii
Power on (normal) 1
Power off 10
Procedure turns 80, 83, 86, 131
Procedures page 40-42
Proximity Waypoints 35, 52

R

RAIM prediction 30
RAIM protection 129
Radar information 41
Receiver status 20-22
Reference waypoint 19
Removal of the GNC 300XL 114
Renaming user waypoints 53

Restoring user data 113
Reversing a route 68
Route catalog page 66
Route comments 66
Route key vii
Route navigation 62, 74
Route RAIM Prediction 71-72
Routes 62-77
Runway page 44
Runway surface 44, 104

S

Satellite acquisition 2
Satellite data page 22
Satellite information 21-22
Satellite status page 2, 11, 20-22
Scheduler 31
Search-and-rescue operations 70
Settings submenus 100
SIDs 40-42, 65-66, 96-97
Simulator mode 115
Special Use Airspace (SUA) 58-61
Specifications 126
Standby frequency 3, 17, 33
STARs 40-42, 65-66, 98-99
Storing user data 112
SUA alert messages 58
SUA alert page 59
SUA altitude fields 60
SUA settings page 61, 102
Sunrise/sunset planning 32
Squelch vii, 35



| | |
|--|---------------|
| T | |
| Table of contents | v-vi |
| Time | 29 |
| Transfer key | viii, 3, 33 |
| Trip planning | 23 |
| Trip timer | 29, 107 |
| Trip timer settings | 107 |
| True air speed | 24 |
| Turn anticipation | 77 |
| U | |
| Unit settings | 100-111 |
| Units of measure | 108 |
| User data cards | 112 |
| User waypoints | 37, 48-51, 53 |
| V | |
| Vertical navigation (VNAV) | 23-26 |
| Volume | vii, 35 |
| VORs | 37, 45 |
| W | |
| Warranty | iv |
| Waypoint categories | 37 |
| Waypoint comment list | 36, 54 |
| Waypoint comments page | 54 |
| Waypoint confirmation page | 55 |
| Waypoint entry | 38 |
| Waypoint holding | 76 |
| Waypoint identification page | 38 |
| Waypoint information | 36-56 |
| Waypoint key | vii, 36 |
| Waypoint list | 53 |
| Waypoint menu | 36-37 |
| Waypoint scanning | 56 |
| Waypoint sequencing | 76-77 |
| Waypoints with comments | 54 |
| Winds aloft | 26 |
| Z | |
| Zoom in/out | 8, 16 |



© 1999 GARMIN Corporation

GARMIN International, Inc., 1200 East 151st Street Olathe, KS 66062

GARMIN (Europe) LTD, Unit 5, The Quadrangle, Abbey Park Industrial Estate, Romsey, SO51 9AQ, UK

GARMIN (Asia) Corp., 4th Fl., No. 1, Lane 45, Pao-Hsing Road, Hsin Tien, Taiwan R.O.C.

Web Site Address: www.garmin.com

Part No. 190-00067-30 Rev. B